

10

SOLUȚII DE ILUMINAT



10 SPOTURI CU LED

1. STAR

Mini spot pentru spații înguste sau plintă



Cod	Finisaj	Lumină
STAR.CH.30K	Crom	Caldă
STAR.CH.40K	Crom	Neutră
STAR.CH.60K	Crom	Rece

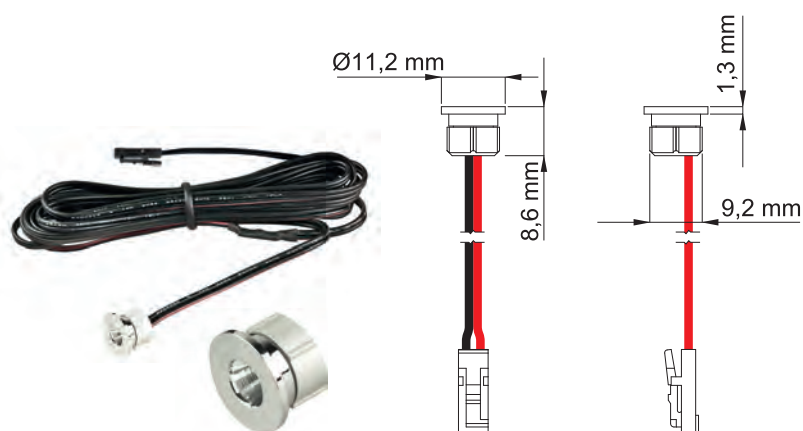

Date tehnice



Lumină/Luminozitate (lm)



Finisaj



2. MAGNETO

Spot cu LED-uri și difuzor de lumină



Cod	Finisaj	Lumină
MAGNETO.A.30K	Alb	Caldă
MAGNETO.A.40K	Alb	Neutră
MAGNETO.A.60K	Alb	Rece

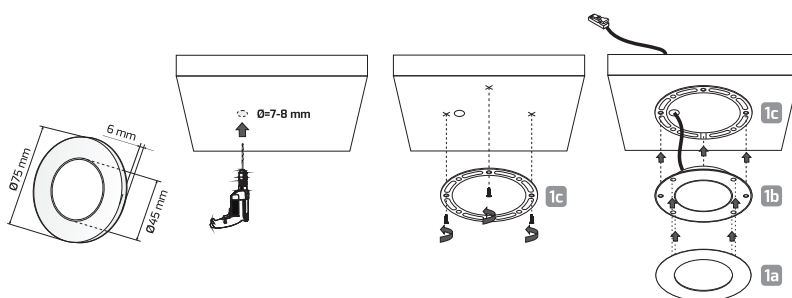

Date tehnice



Lumină/Luminozitate (lm)



Finisaj



3. FOTON

Spot cu LED-uri și difuzor de lumină

Cod	Finisaj	Lumină
FOTON.A.30K	Alb	Caldă
FOTON.A.40K	Alb	Neutră
FOTON.A.60K	Alb	Rece
FOTON.AL.30K	Aluminiu	Caldă
FOTON.AL.40K	Aluminiu	Neutră
FOTON.AL.60K	Aluminiu	Rece



Date tehnice



Lumină/Luminozitate (lm)



Finisaj



10 SPOTURI CU LED

4. SQUARE 2

Spot cu 16 LED-uri

Cod	Finisaj	Lumină
SQUARE2.AL.30K	Aluminiu	Caldă
SQUARE2.AL.40K	Aluminiu	Neutră
SQUARE2.AL.60K	Aluminiu	Rece
SQUARE2.A.30K	Alb	Caldă
SQUARE2.A.40K	Alb	Neutră
SQUARE2.A.60K	Alb	Rece
SQUARE2.N.30K	Negru	Caldă
SQUARE2.N.40K	Negru	Neutră
SQUARE2.N.60K	Negru	Rece

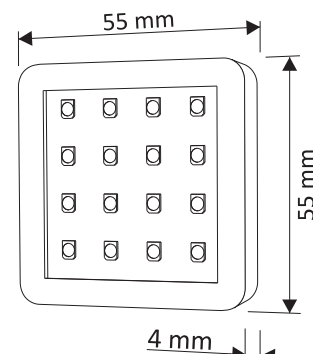

Date tehnice



Lumină/Luminozitate (lm)



Finisaj



5. SQUARE 2 SET

Set cu 3 spoturi LED Square 2, transformator 15W și distribuitor 6 ieșiri

Cod	Finisaj	Lumină
SET SQUARE2.AL.30K	Aluminiu	Caldă
SET SQUARE2.AL.60K	Aluminiu	Rece

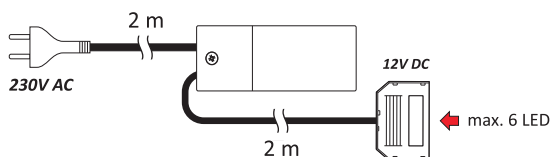

Date tehnice



Lumină/Luminozitate (lm)



Finisaj



Sistemul poate susține până la 6 spoturi

6. SQUARE 3

Spot cu 9 LED-uri premium

Cod	Finisaj	Lumină
SQUARE3.AL.30K	Aluminiu	Caldă
SQUARE3.AL.40K	Aluminiu	Neutră
SQUARE3.AL.60K	Aluminiu	Rece

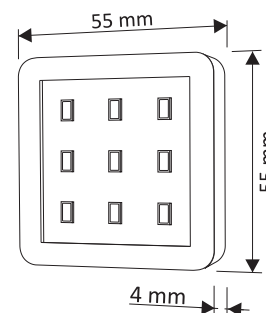

Date tehnice



Lumină/Luminozitate (lm)



Finisaj



LED modern - cu 100% mai multă lumină.



10 SPOTURI CU LED

7. SQUARE RGB

Spot RGB cu 9 LED-uri

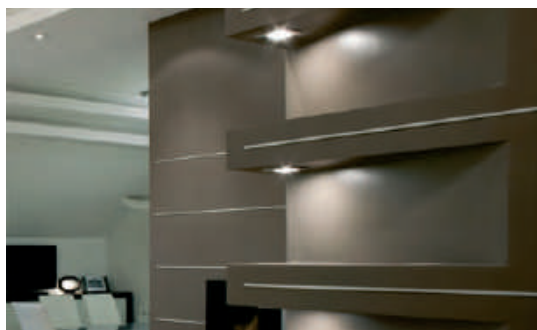

Cod	Finisaj	Lumină
SQUARE2.AL.RGB	Aluminiu	RGB

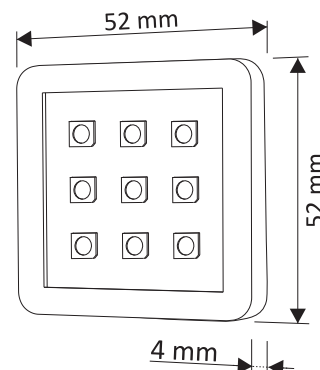

Date tehnice



Lumină/Luminozitate (lm)



Finisaj



8. SQUARE RGB SET

Set cu 3 spoturi LED Square RGB, controler, telecomandă, transformator 18W și distribuitor 9 ieșiri

Cod	Finisaj	Lumină
SET SQUARE2.AL.RGB	Aluminiu	RGB

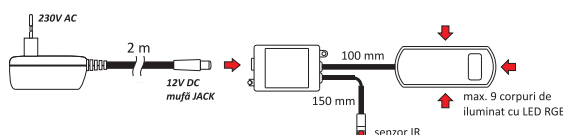
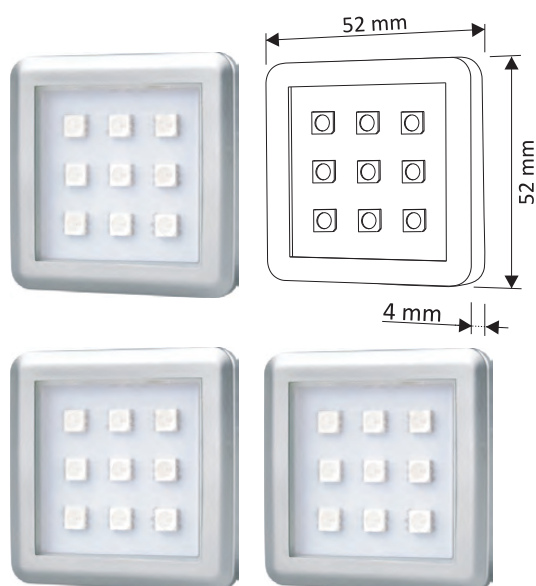

Date tehnice



Lumină/Luminozitate (lm)



Finisaj



Listă preț
Spoturi cu LED



10 SPOTURI CU LED

9. OVAL SLANT

Spot metalic cu LED-uri, oblic

Cod	Finisaj	Lumină
OVAL S.30K	Metal periat	Caldă
OVAL S.60K	Metal periat	Rece



10. OVAL SLANT MASTER

Spot Master, metalic, cu LED-uri, oblic, cu rol de comutator

Cod	Finisaj	Lumină
OVAL MASTER.30K	Metal periat	Caldă
OVAL MASTER.60K	Metal periat	Rece

- ▶ Spotul Master controlează corpurile de iluminat conectate la acesta.
- ▶ Cu o singură atingere, lumina se aprinde sau se stinge.
- ▶ Suportă max. 36W.
- ▶ La spotul Master puteți conecta orice corp de iluminat cu LED din oferta noastră (spoturi, profile sau benzi).

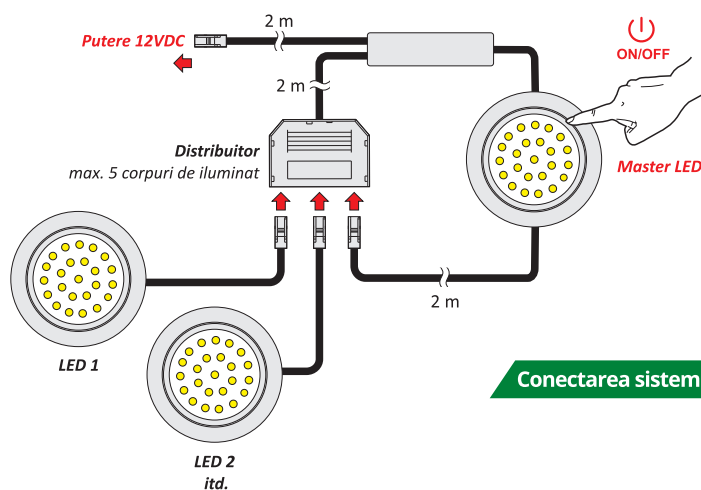

Conectarea sistemului

Date tehnice

Lumină/Luminozitate (lm) Finisaj



10 SPOTURI CU LED

11. OVAL

Spot metalic cu LED-uri

Cod	Finisaj	Lumină
OVAL.AL.30K	Aluminiu	Caldă
OVAL.AL.40K	Aluminiu	Neutră
OVAL.AL.60K	Aluminiu	Rece
OVAL.AN.30K	Antichizat	Caldă
OVAL.AN.60K	Antichizat	Rece
OVAL.A.30K	Alb	Caldă
OVAL.A.60K	Alb	Rece
OVAL.N.30K	Negru	Caldă
OVAL.N.60K	Negru	Rece
OVAL.MP.30K	Metal periat	Caldă
OVAL.MP.40K	Metal periat	Neutră
OVAL.MP.60K	Metal periat	Rece

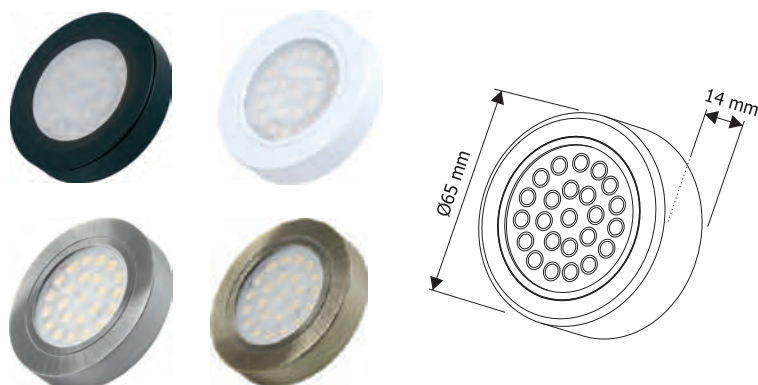

* Lumina neutră este disponibilă numai pentru spoturile cu finisaj AL și metal periat.

Date tehnice



Lumină/Luminozitate (lm)



Finisaj



12. OVAL SET

Set cu 3 spoturi Oval, transformator 15W, distribuitor cu 6 ieșiri



Cod	Finisaj	Lumină
SETOVAL.MP.30K	Metal periat	Caldă
SETOVAL.MP.60K	Metal periat	Rece

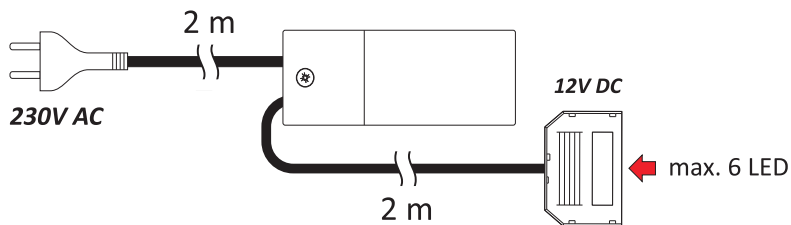

Date tehnice



Lumină/Luminozitate (lm) Finisaj



13. OVAL 2

Spot metalic cu LED-uri, montaj încastrat



Cod	Finisaj	Lumină
OVAL2.AL.30K	Aluminiu	Caldă
OVAL2.AL.60K	Aluminiu	Rece
OVAL2.MP.30K	Metal periat	Caldă
OVAL2.MP.60K	Metal periat	Rece

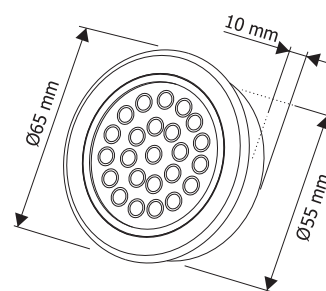

Date tehnice



Lumină/Luminozitate (lm) Finisaj



14. ORBIT PIR

Spot cu senzor de mișcare încorporat

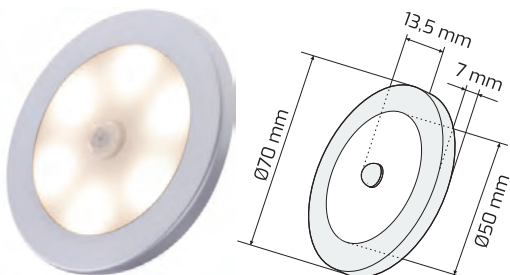

Orbit PIR se montează cu ușurință la suprafața plăcii și este ideal pentru a fi utilizat în interiorul dulapurilor. Se aprinde când detectează mișcare și se stinge automat.

Cod	Finisaj	Lumină
ORBITPIR.AL.30K	Aluminiu	Caldă
ORBITPIR.AL.40K	Aluminiu	Neutră
ORBITPIR.AL.60K	Aluminiu	Rece

Date tehnice



Lumină/Luminozitate (lm) Finisaj

Sistemul poate susține până la 6 spoturi

15. ORBIT

Spot cu 16 LED-uri

Cod	Finisaj	Lumină
ORBIT.AL.30K	Aluminiu	Caldă
ORBIT.AL.40K	Aluminiu	Neutră
ORBIT.AL.60K	Aluminiu	Rece
ORBIT.A.30K	Alb	Caldă
ORBIT.A.40K	Alb	Neutră
ORBIT.A.60K	Alb	Rece
ORBIT.N.30K	Negru	Caldă
ORBIT.N.40K	Negru	Neutră
ORBIT.N.60K	Negru	Rece



Date tehnice

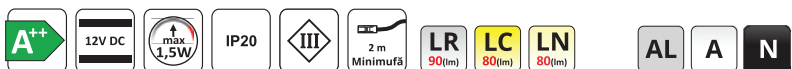

Lumină/Luminozitate (lm) Finisaj

16. ORBIT SET

Set cu 3 spoturi LED Orbit, transformator 15W

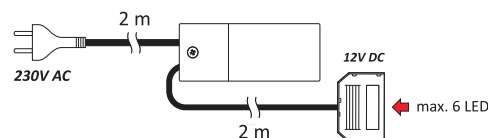

Cod	Finisaj	Lumină
SETORBIT.AL.30K	Aluminiu	Caldă
SETORBIT.AL.60K	Aluminiu	Rece

Date tehnice



Lumină/Luminozitate (lm) Finisaj

17. ORBIT XL

Spot cu 9 LED-uri premium

Cod	Finisaj	Lumină
ORBITXL.AL.30K	Aluminiu	Caldă
ORBITXL.AL.40K	Aluminiu	Neutră
ORBITXL.AL.60K	Aluminiu	Rece
ORBITXLA.30K	Alb	Caldă
ORBITXLA.40K	Alb	Neutră
ORBITXLA.60K	Alb	Rece
ORBITXL.N.30K	Negru	Caldă
ORBITXL.N.40K	Negru	Neutră
ORBITXL.N.60K	Negru	Rece



Date tehnice



Lumină/Luminozitate (lm)



Finisaj



18. ORBIT XL MASTER

Spot Orbit XL Master, cu LED-uri, cu rol de comutator

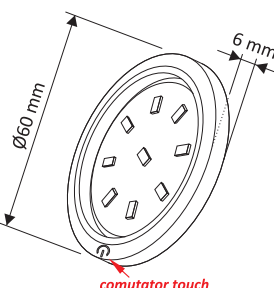

Conectarea sistemului suportă max. 36W.

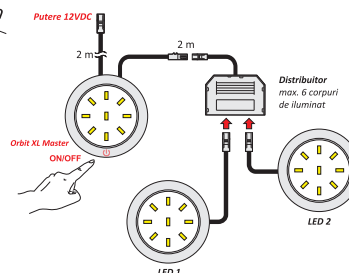

Cod	Finisaj	Lumină
ORBITXL MASTER.AL.30K	Aluminiu	Caldă
ORBITXL MASTER.AL.40K	Aluminiu	Neutră
ORBITXL MASTER.AL.60K	Aluminiu	Rece

Date tehnice



Lumină/Luminozitate (lm)



Finisaj



Scanează codul QR și vezi cum funcționează.

19. ORBIT XL SET

Set cu 1 spot Orbit XL Master și 2 spoturi Orbit XL, transformator 14W

Cod	Finisaj	Lumină
SETORBITXL.AL.30K	Aluminiu	Caldă
SETORBITXL.AL.40K	Aluminiu	Neutră
SETORBITXL.AL.60K	Aluminiu	Rece

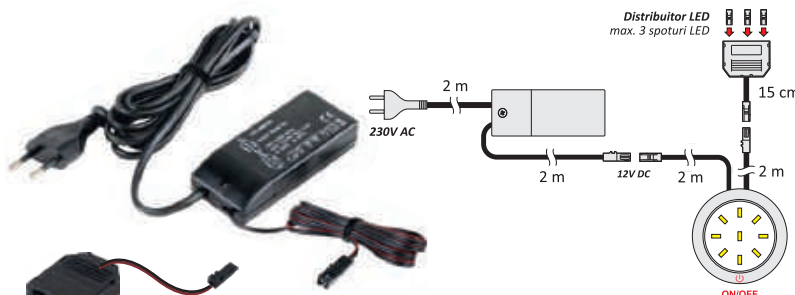

Date tehnice



Lumină/Luminozitate (lm) Finisaj



20. PUPIL

Profil din aluminiu cu bandă LED inclusă

Cod	Finisaj	Lumină
PUPIL.30K	Aluminiu	Caldă
PUPIL.60K	Aluminiu	Rece



Listă preț
Profile LED



21. PUPIL MASTER

Profil din aluminiu cu bandă LED inclusă, cu rol de comutator

Cod	Finisaj	Lumină
PUPIL MASTER.30K	Aluminiu	Caldă
PUPIL MASTER.60K	Aluminiu	Rece



Instalare simplă

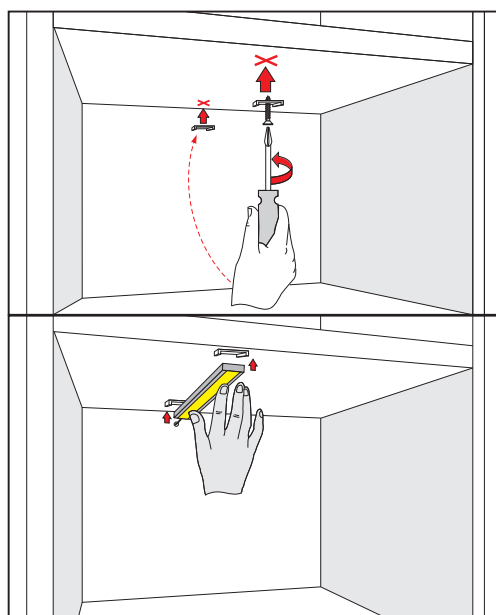

Sunt incluse 2 cleme pentru fixarea profilului

Conectarea sistemului

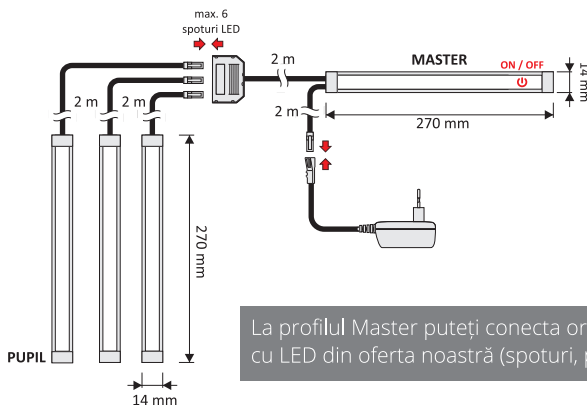

La profilul Master puteți conecta orice corp de iluminat cu LED din oferta noastră (spoturi, profile sau benzi).



Scanează codul QR
și vezi cum funcționează.

Date tehnice

Lumină/Luminozitate (lm) Finisaj



10 PROFILE CU BANDĂ LED



22. FUTURA XC

Corp de iluminat pentru corpurile suspendate

- ▶ Asigură un flux luminos continuu, ce iluminează perfect blatul de bucătărie
- ▶ Întrerupător touch XC60 încorporat
- ▶ Dotat cu cablu de 2 m cu mini-mufă
- ▶ Întrerupătorul poate fi poziționat la stânga sau la dreapta capătului profilului
- ▶ Se realizează la comandă, în funcție de dimensiunile solicitate
- ▶ La comandă, menționați lungimea, tipul de lumină și poziționarea întrerupătorului

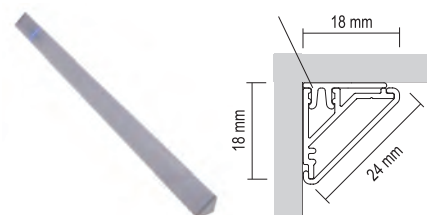

Date tehnice

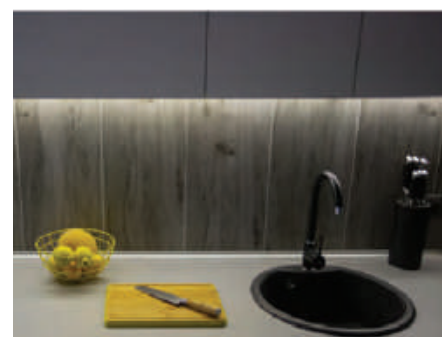
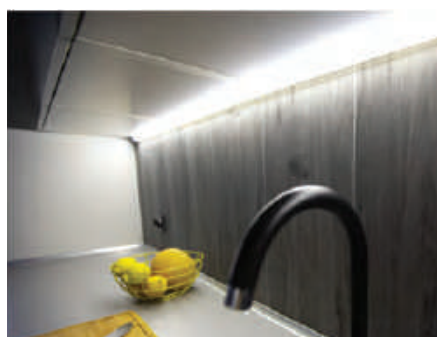
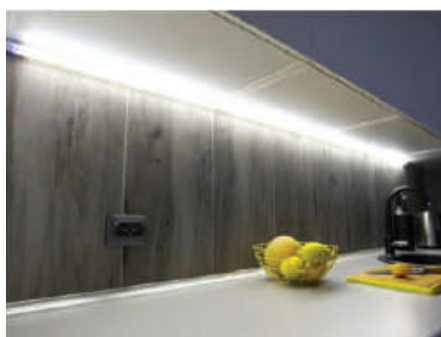

Cod	L (mm)	W*
FUTURA.XC.4	400 - 499	9
FUTURA.XC.5	500 - 599	11
FUTURA.XC.6	600 - 699	13
FUTURA.XC.7	700 - 799	15
FUTURA.XC.8	800 - 899	17
FUTURA.XC.9	900 - 999	19
FUTURA.XC.10	1000 - 1099	21
FUTURA.XC.11	1100 - 1199	23

Cod	L (mm)	W*
FUTURA.XC.12	1200 - 1299	25
FUTURA.XC.13	1300 - 1399	27
FUTURA.XC.14	1400 - 1499	29
FUTURA.XC.15	1500 - 1599	31
FUTURA.XC.16	1600 - 1699	33
FUTURA.XC.17	1700 - 1799	35
FUTURA.XC.18	1800 - 1899	37
FUTURA.XC.19	1900 - 2000	39

W* - consumul corpului de iluminat

La codurile din tabel, adăugați:

- ▶ dimensiunea exactă (în milimetri)
- ▶ tipul de lumină**
- ▶ poziționarea întrerupătorului***

**

- 30K pentru lumina caldă
- 40K pentru lumina neutră
- 60K pentru lumina rece

- ST pentru stânga
- DR pentru dreapta

CODUL DE PRODUS PENTRU COMANDĂ

Specificații	Exemplu 1	Exemplu 2
Cod de articol	FUTURA.XC.8	FUTURA.XC.13
Lungime (milimetri)	840	1355
Tipul de lumina	30K	60K
Poziționarea întrerupătorului	STÂNGA	DREAPTA
Cod produs	FUTURA.XC.8.840.30K.ST	FUTURA.XC.13.1355.60K.DR



**Listă preț
Corpuri
de iluminat**



10 PROFILE CU BANDĂ LED

23. FUTURA PIR

Profil cu bandă LED cu senzor de proximitate pentru dulapuri

- ▶ Asigură un flux luminos continuu, ce iluminează perfect interiorul dulapului. Când senzorul detectează mișcarea, aprinde lumina și o stinge după 35 de secunde, dacă nu detectează altă mișcare. Senzorul poate fi poziționat la stânga sau la dreapta capătului profilului. Alimentarea se realizează prin capătul în care este poziționat senzorul.
- ▶ Lumina este direcționată în interiorul dulapului, astfel încât să nu deranjeze utilizatorul.
- ▶ Se realizează la comandă, în funcție de dimensiunile solicitate. Menționați lungimea, tipul de lumină și poziționarea întrerupătorului.

Bandă LED inclusă

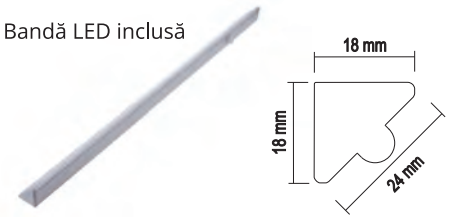

Date tehnice

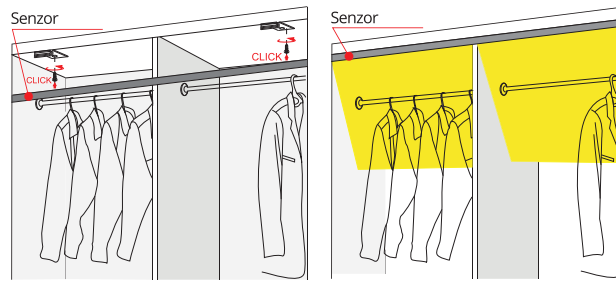
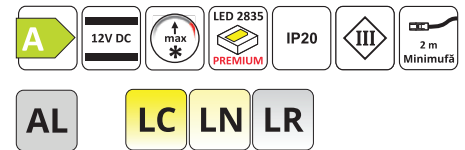

Cod	L (mm)	W*	Cod	L (mm)	W*
FUTURA.PIR.4	400 - 499	9	FUTURA.PIR.12	1200 - 1299	25
FUTURA.PIR.5	500 - 599	11	FUTURA.PIR.13	1300 - 1399	27
FUTURA.PIR.6	600 - 699	13	FUTURA.PIR.14	1400 - 1499	29
FUTURA.PIR.7	700 - 799	15	FUTURA.PIR.15	1500 - 1599	31
FUTURA.PIR.8	800 - 899	17	FUTURA.PIR.16	1600 - 1699	33
FUTURA.PIR.9	900 - 999	19	FUTURA.PIR.17	1700 - 1799	35
FUTURA.PIR.10	1000 - 1099	21	FUTURA.PIR.18	1800 - 1899	37
FUTURA.PIR.11	1100 - 1199	23	FUTURA.PIR.19	1900 - 2000	39

W* - consumul corpului de iluminat

La codurile din tabel, adăugați:

- ▶ dimensiunea exactă (în milimetri)
- ▶ tipul de lumină**
- ▶ poziționarea întrerupătorului***

**
30K pentru lumina caldă
40K pentru lumina neutră
60K pentru lumina rece

ST pentru stânga
DR pentru dreapta

Listă preț Corpuri de iluminat

CODUL DE PRODUS PENTRU COMANDĂ

Specificații	Exemplu 1	Exemplu 2
Cod de articol	FUTURA.PIR.6	FUTURA.PIR.17
Lungime (milimetri)	625	1750
Tipul de lumină	40K	60K
Poziționarea întrerupătorului	STÂNGA	DREAPTA
Cod produs	FUTURA.PIR.6.625.40K.ST	FUTURA.PIR.17.1750.60K.DR



24. POLISTAR

Corp de iluminat pentru cornișă

Cod	Finisaj	Lumină
POLISTAR.30K	Aluminiu	Caldă
POLISTAR.60K	Aluminiu	Rece

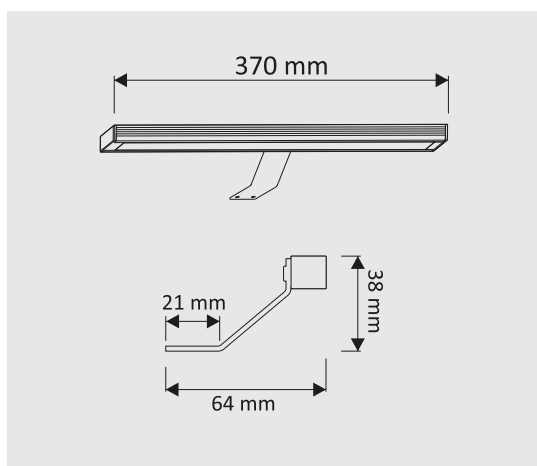

Date tehnice



Lumină/Luminozitate (lm) Finisaj

25. CAPRI

Corp de iluminat pentru cornișă

Cod	Finisaj	Lumină
CAPRI.30K	Aluminiu	Caldă
CAPRI.60K	Aluminiu	Rece

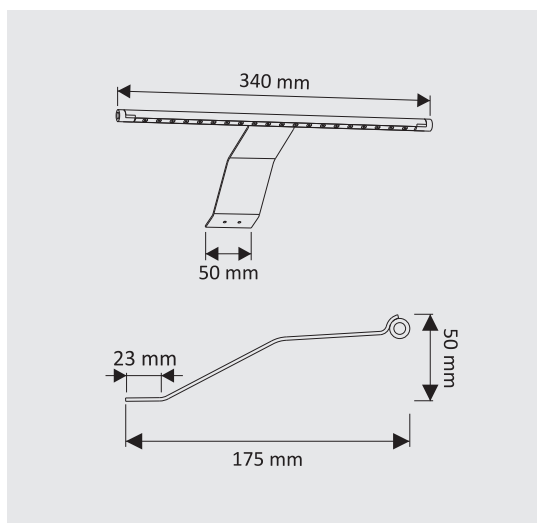

Date tehnice



Lumină/Luminozitate (lm) Finisaj

26. AMBER UNIVERSAL

Corp de iluminat pentru baie, cu montaj pe corp sau pe oglindă

Cod	Finisaj	Lumină
AMBERU.30K	Crom	Caldă
AMBERU.40K	Crom	Neutră
AMBERU.60K	Crom	Rece
AMBERU.N.30K	Negru	Caldă
AMBERU.N.40K	Negru	Neutră
AMBERU.N.60K	Negru	Rece



Două opțiuni de montaj, un singur produs

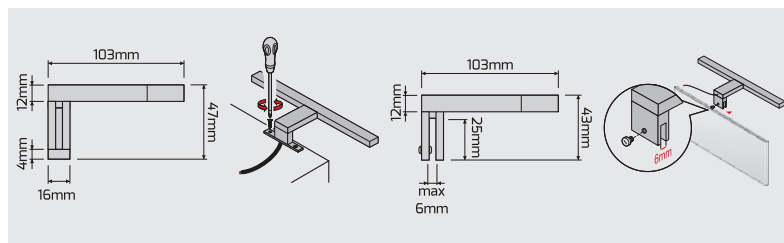
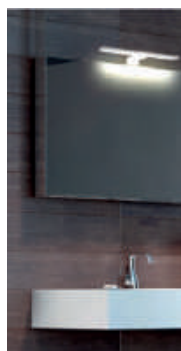

Date tehnice



Lumină/Luminozitate (lm)

Finisaj



27. STEP LED

Corp de iluminat pentru holuri, scări, plintă

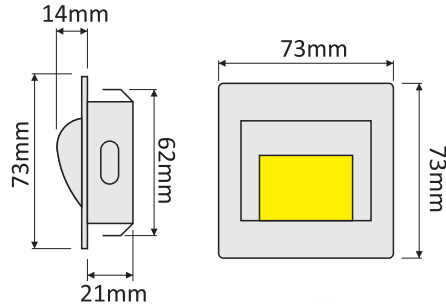

Cod	Finisaj	Lumină
STEP.I.40K	Inox	Neutră
STEP.AN.40K	Antichizat	Neutră
STEP.N.40K	Negru	Neutră
STEP.A.40K	Alb	Neutră

Date tehnice



Lumină/Luminozitate (lm)



Finisaj



28. POLARUS P

Profil cu bandă LED pentru sertare

Cod	L (mm)	W	Lm
POL.414.30K	414	3	224
POL.414.60K	414	3	224
POL.564.30K	564	5	364
POL.564.60K	564	5	364
POL.764.30K	764	7	524
POL.764.60K	764	7	524
POL.864.30K	864	8	604
POL.864.60K	864	8	604
POL.964.30K	964	9	684
POL.964.60K	964	9	684
POL.1164.30K	1164	11	844
POL.1164.60K	1164	11	844

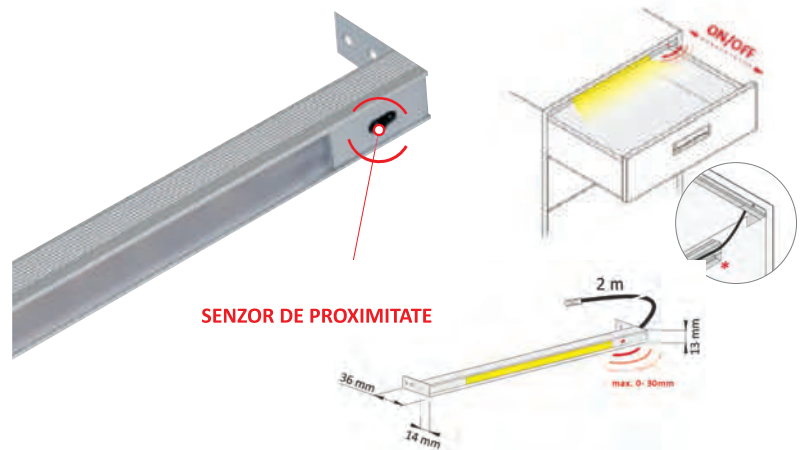

Scanează codul QR și vezi cum funcționează.

Date tehnice



Finisaj



10 CORPURI DE ILUMINAT CU LED

29. CORNER

Corp de iluminat cu priză și întrerupător

Cod	Finisaj	Lumină
CORNER	Aluminiu	Neutră

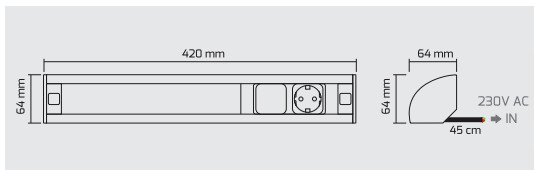

Date tehnice

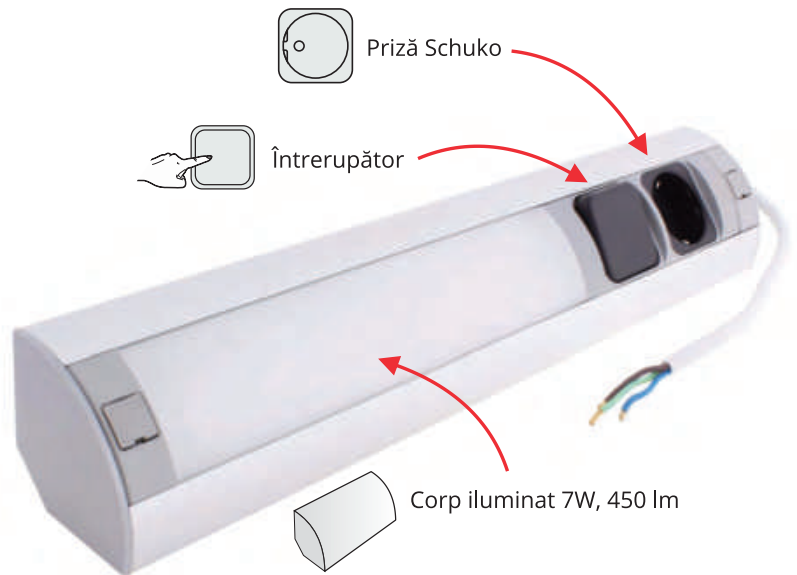

30. MODUS TOUCH USB

Corp de iluminat cu LED, cu braț reglabil, cu touch și port USB

Cod	Finisaj	Lumină
MODUS.A.T.USB	Alb	Caldă
MODUS.N.T.USB	Negru	Caldă

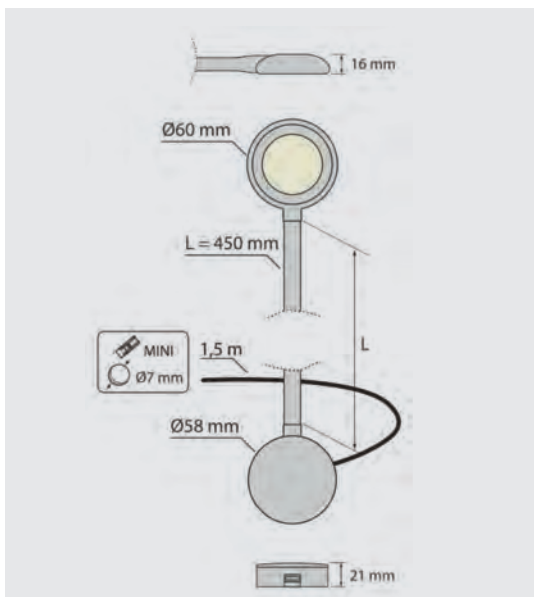

Date tehnice

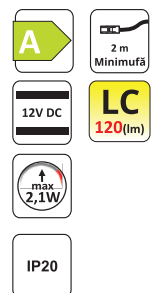

31. CLIP 3D

Clip LED pentru polițe din sticlă, iluminare în trei direcții

Cod	Finisaj	Lumină
CLIP3D.N.30K	Negru	Caldă
CLIP3D.N.40K	Negru	Neutră
CLIP3D.N.60K	Negru	Rece
CLIP3D.AL.30K	Aluminiu	Caldă
CLIP3D.AL.40K	Aluminiu	Neutră
CLIP3D.AL.60K	Aluminiu	Rece

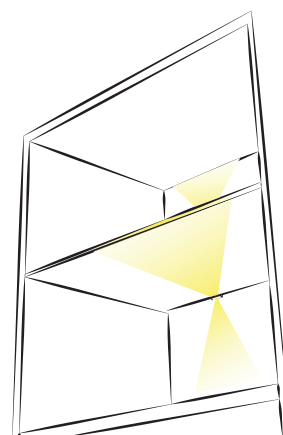

Date tehnice

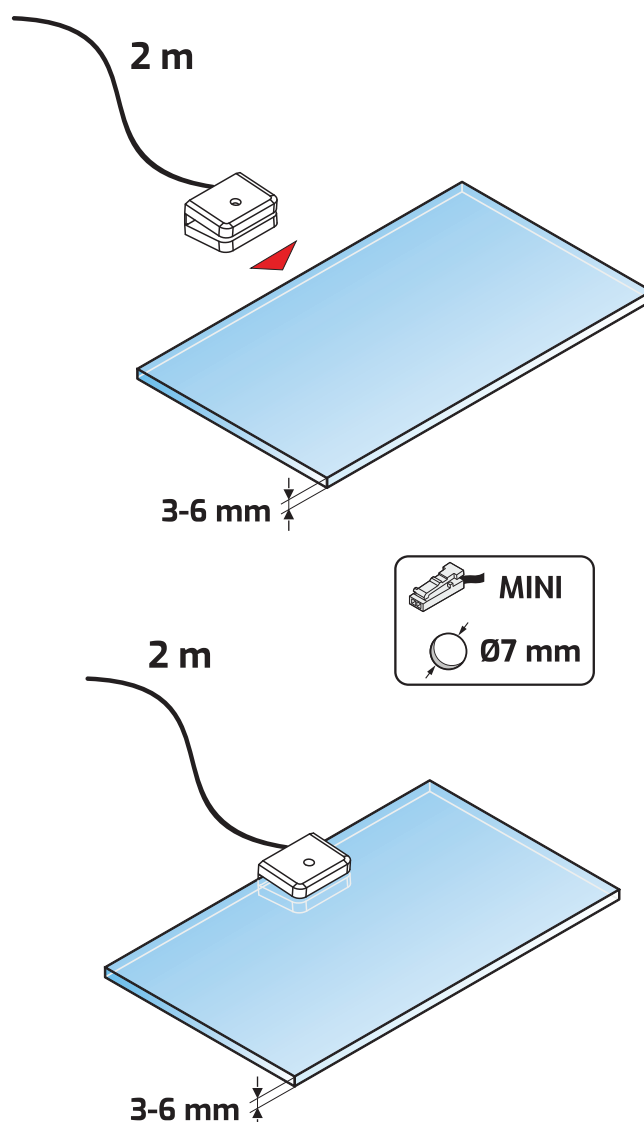
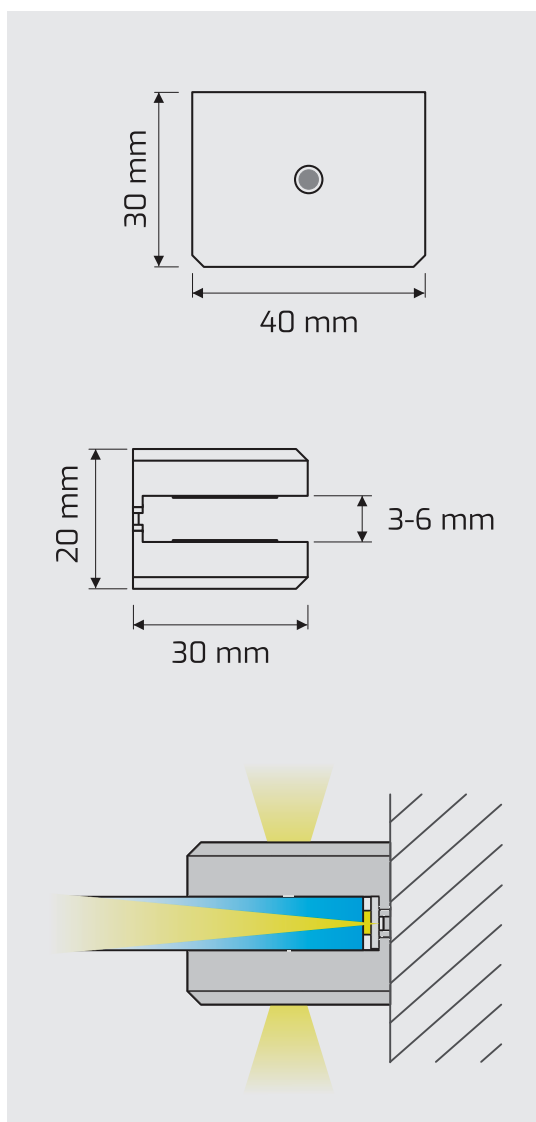

32. LED CLIP METAL

Miniprofil metalic cu bandă LED pentru polițe din sticlă

Cod	Finisaj	Lumină
CLIPM.30K	Metal periat	Caldă
CLIPM.60K	Metal periat	Rece
CLIPM.R	Metal periat	Roșie
CLIPM.AB	Metal periat	Albastră
CLIPM.V	Metal periat	Verde



Date tehnice



Lumină/Luminozitate (lm)

Finisaj

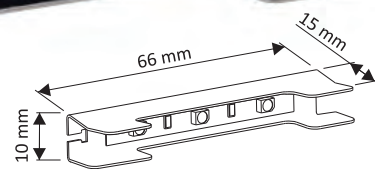

33. LED CLIP PVC

Miniprofil plastic transparent cu bandă LED pentru polițe din sticlă

Cod	Finisaj	Lumină
CLIPP.30K	Transparent	Caldă
CLIPP.60K	Transparent	Rece
CLIPP.R	Transparent	Roșie
CLIPP.AB	Transparent	Albastră
CLIPP.V	Transparent	Verde

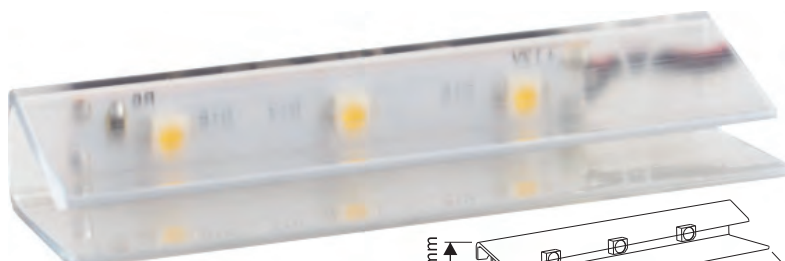

Date tehnice



Lumină/Luminozitate (lm)

Finisaj

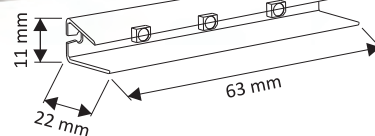

34. LED CLIP RGB

Miniprofil RGB, plastic sau metalic

Cod	Finisaj	Lumină
CLIPP.RGB	Transparent	RGB
CLIPM.RGB	Metal periat	RGB

Date tehnice



Lumină/Luminozitate (lm)

Finisaj

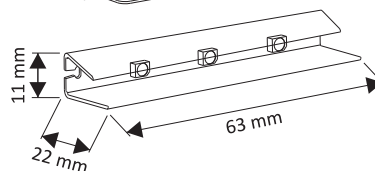
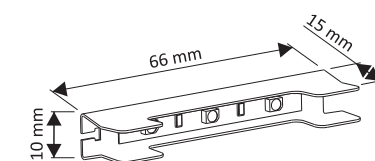

35. LED CLIP METAL SET

Set cu 2 miniprofile metalice cu bandă LED pentru polițe din sticlă



Date tehnice



Lumină/Luminozitate (lm)



Finisaj



Setul conține:

- ▶ 2 x miniprofile
- ▶ 1 x întrerupător de picior
- ▶ 1 x transformator
- ▶ 1 x distribuitor 6 ieșiri

* Sistemul poate susține pâna la 6 miniprofile

Cod	Finisaj	Lumină
SET CLIPM.30K	Metal periat	Caldă
SET CLIPM.60K	Metal periat	Rece
SET CLIPM.R	Metal periat	Roșie
SET CLIPM.AB	Metal periat	Albastră
SET CLIPM.V	Metal periat	Verde

36. LED CLIP PVC SET

Set cu 2 miniprofile plastic transparent cu bandă LED pentru polițe din sticlă



Date tehnice



Lumină/Luminozitate (lm)



Finisaj



Setul conține:

- ▶ 2 x miniprofile
- ▶ 1 x întrerupător de picior
- ▶ 1 x transformator
- ▶ 1 x distribuitor 6 ieșiri

* Sistemul poate susține pâna la 6 miniprofile

Cod	Finisaj	Lumină
SET CLIPP.30K	Transparent	Caldă
SET CLIPP.60K	Transparent	Rece
SET CLIPP.R	Transparent	Roșie
SET CLIPP.AB	Transparent	Albastră
SET CLIPP.V	Transparent	Verde

37. LED CLIP RGB PVC SET

Set cu 2 miniprofile plastic transparent cu bandă LED pentru polițe din sticlă

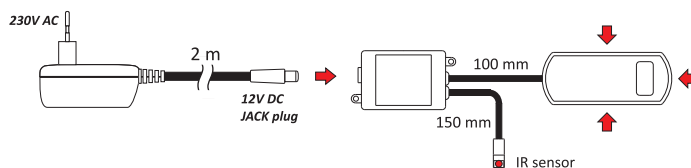

Setul conține:

- ▶ 2 x miniprofile
- ▶ 1 x transformator
- ▶ 1 x controler
- ▶ 1 x distribuitor 9 ieșiri
- ▶ 1 x telecomandă

* Sistemul poate susține pâna la 9 miniprofile

Cod	Finisaj	Lumină
SET CLIPP.RGB	Transparent	RGB



Date tehnice



Lumină/Luminozitate (lm) Finisaj



10 PROFILE ALUMINIU PENTRU BANDĂ LED

38. INLINE MINI XL

Profil din aluminiu pentru bandă LED, cu difuzor opac, finisaj aluminiu, alb sau negru, bară 2 m și 3 m



NOU! Profilele **INLINE MINI XL** și **LINE MINI** sunt disponibile la comandă și în finisaj auriu.

Mai multe informații.

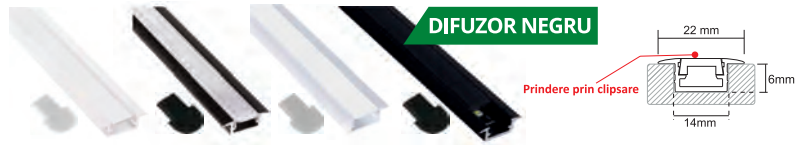

Cod	Produs	Finisaj / Difuzor	U.M.
INLINEMXL.AL.2M	Profil Inline Mini XL	Aluminiu / opac	Bară 2 m
CAP.INLINEMXL.AL	Capac pentru capăt	Gri	Buc.
INLINEMXL.A.2M	Profil Inline Mini XL	Alb / opac	Bară 2 m
CAP.INLINEMXL.A	Capac pentru capăt	Alb	Buc.
INLINEMXL.N.2M	Profil Inline Mini XL	Negru / opac	Bară 2 m
INLINEMXL.TR.N.2M	Profil Inline Mini XL	Negru / negru	Bară 2 m
CAP.INLINEMXL.N	Capac pentru capăt	Negru	Buc.
INLINEMXL.AL.3M	Profil Inline Mini XL	Aluminiu / opac	Bară 3 m
INLINEMXL.TR.N.3M	Profil Inline Mini XL	Negru / negru	Bară 3 m
INLINEMXL.A.3M	Profil Inline Mini XL	Alb / opac	Bară 3 m

*Profilele includ difuzorul opac. Capacele se comandă separat.

39. LINE MINI

Profil din aluminiu pentru bandă LED, cu difuzor opac, finisaj aluminiu, alb sau negru, bară 2 m și 3 m

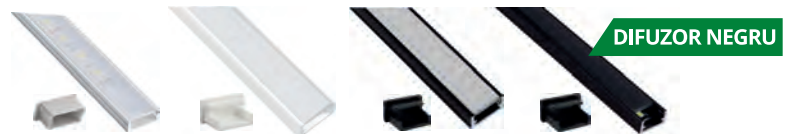
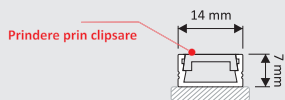

Cod	Produs	Finisaj / Difuzor	U.M.
LINEMINI.AL.2M	Profil Line Mini	Aluminiu / opac	Bară 2 m
CAP.LINEMINI.AL.01	Capac pentru capăt	Gri	Buc.
LINEMINI.A.2M	Profil Line Mini	Alb / opac	Bară 2 m
CAP.LINEMINI.A.01	Capac pentru capăt	Alb	Buc.
LINEMINI.N.2M	Profil Line Mini	Negru / opac	Bară 2 m
LINEMINI.TR.N.2M	Profil Line Mini	Negru / negru	Bară 2 m
CAP.LINEMINI.N.01	Capac pentru capăt	Negru	Buc.
LINEMINI.AL.3M	Profil Line Mini	Aluminiu / opac	Bară 3 m
LINEMINI.A.3M	Profil Line Mini	Alb / opac	Bară 3 m
LINEMINI.TR.N.3M	Profil Line Mini	Negru / negru	Bară 3 m

*Profilele includ difuzorul opac. Capacele se comandă separat.

40. LINE XL

Profil din aluminiu pentru bandă LED, cu difuzor opac, finisaj aluminiu, bară 2 m

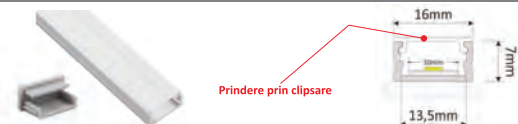
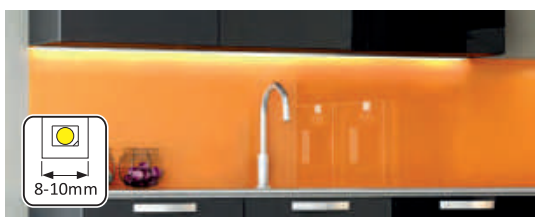

Cod	Produs	Finisaj / Difuzor	U.M.
LINEXL.AL.2M	Profil Line XL	Aluminiu	Bară 2 m
CAP.LINEXL.AL	Capac pentru capăt	Gri	Buc.

*Profilele includ difuzorul opac. Capacele se comandă separat.



10 PROFILE ALUMINIU PENTRU BANDĂ LED

41. TRI-LINE MINI

Profil triunghiular din aluminiu pentru bandă LED, cu difuzor opac, finisaj aluminiu, alb sau negru, bară 2 m și 3 m

Prindere prin clipsare

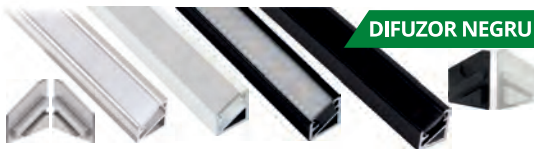
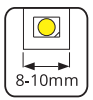
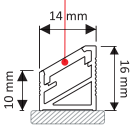

Cod	Produs	Finisaj / Difuzor	U.M.
TRILINEMINI.AL.2M	Profil Tri-Line Mini	Aluminiu / opac	Bară 2 m
CAP.TRILINEMINI.S.AL.01	Capac pentru capăt, stânga	Gri	Buc.
CAP.TRILINEMINI.D.AL.01	Capac pentru capăt, dreapta	Gri	Buc.
TRILINEMINI.A.2M	Profil Tri-Line Mini	Alb / opac	Bară 2 m
CAP.TRILINEMINI.S.A	Capac pentru capăt, stânga	Alb	Buc.
CAP.TRILINEMINI.D.A	Capac pentru capăt, dreapta	Alb	Buc.
TRILINEMINI.N.2M	Profil Tri-Line Mini	Negru / opac	Bară 2 m
TRILINEMINI.TR.N.2M	Profil Tri-Line Mini	Negru / negru	Bară 2 m
CAP.TRILINEMINI.S.N	Capac pentru capăt, stânga	Negru	Buc.
CAP.TRILINEMINI.D.N	Capac pentru capăt, dreapta	Negru	Buc.
TRILINEMINI.A.3M	Profil Tri-Line Mini	Alb / opac	Bară 3 m
TRILINEMINI.AL.3M	Profil Tri-Line Mini	Aluminiu / opac	Bară 3 m

*Profilele includ difuzorul opac. Capacele se comandă separat.

42. TRI-LINE

Profil triunghiular din aluminiu pentru bandă LED, cu difuzor, finisaj aluminiu, bară 2 m

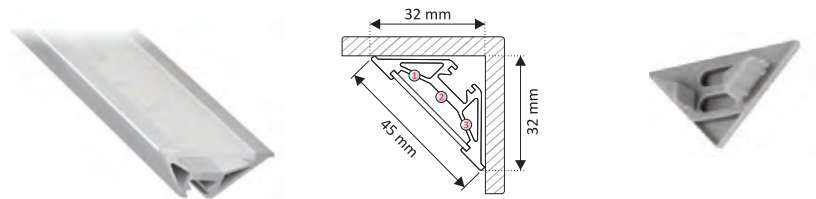
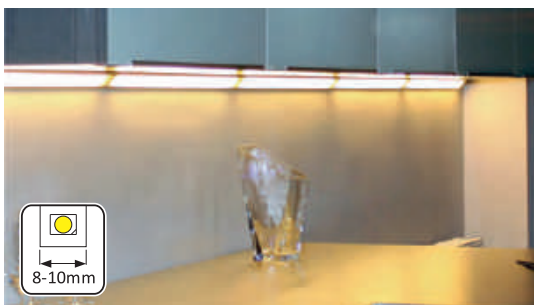

Cod	Produs	Finisaj / Difuzor	U.M.
TRILINE.AL.2M	Profil Tri-Line	Aluminiu	Bară 2 m
CAP.TRILINE.AL	Capac pentru capăt	Gri	Buc.

*Profilele includ difuzorul opac. Capacele se comandă separat.

43. CLEME PENTRU PRINDEREA PROFILELOR CU BANDĂ LED

Profil din aluminiu pentru bandă LED, cu difuzor opac, finisaj aluminiu, bară 2 m

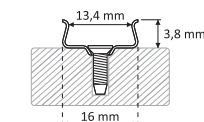

Clemele pentru profilele Line, Line Mini, Tri-Line Mini.

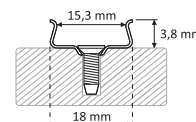

Clemele pentru profilele Line XL.

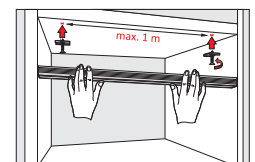

Cod	Produs	Finisaj / Difuzor	U.M.
CLEM.PROF.01	Clemă + șurub (Line, Line Mini, Tri-Line Mini)	Aluminiu	Set
CLEM.PROF.02	Clemă + șurub (Line XL)	Aluminiu	Set

*Setul include 1 clemă și 1 șurub.
Vă recomandăm utilizarea a două cleme la fiecare 1 metru de profil.

10 PROFILE ALUMINIU PENTRU BANDĂ LED

44. ZENOLINE

Profil triunghiular din aluminiu pentru bandă LED, cu difuzor opac, finisaj aluminiu, alb sau negru, bară 2 m



Cod	Produs	Finisaj / Difuzor	U.M.
ZENOLINE.A.2M	Profil Zenoline	Alb	Bară 2 m
CAP.ZENOLINE.A	Capac pentru capăt	Alb	Buc.
ZENOLINE.N.2M	Profil Zenoline	Negru	Bară 2 m
CAP.ZENOLINE.N	Capac pentru capăt	Negru	Buc.
ZENOLINE.AL.2M	Profil Zenoline	Aluminiu	Bară 2 m
CAP.ZENOLINE.AL	Capac pentru capăt	Gri	Buc.

*Profilele includ difuzorul opac. Capacele se comandă separat.

45. BARĂ PENTRU UMERĂȘE

Bară pentru umerășe cu canal pentru bandă LED, bară 2 m



Cod	Produs	Finisaj / Difuzor	U.M.
BAR.AL.2M	Bară umerășe	Aluminiu	Bară 2 m
SUP.BAR.AL	Suport bară umerășe	Plastic	Set

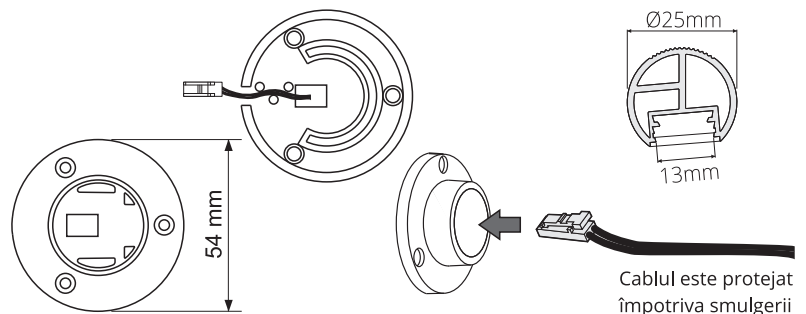

46. CORNER LINE

Profil triunghiular din aluminiu pentru bandă LED, cu difuzor, finisaj aluminiu, bară 2 m

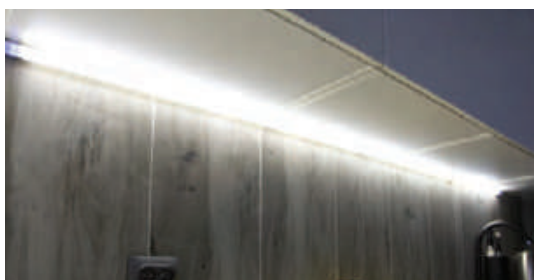

Cod	Produs	Finisaj / Difuzor	U.M.
CORNERLINE.AL.2M	Profil Corner Line	Aluminiu	Bară 2 m
CAP.CORNERLINE.AL	Capac pentru capăt	Gri	Buc.
CLEM.PROF.03	Clemă prindere profil	Gri	Buc.

10 PROFILE ALUMINIU PENTRU BANDĂ LED

47. SKYLINE 2

Profil din aluminiu pentru bandă LED, finisaj aluminiu, bară 2 m, difuzor opac pentru corpuri superioare fără mâner



Cod	Produs	Finisaj / Difuzor	U.M.
SKYLINE2.AL.2M	Profil Skyline 2	Aluminiu	Bară 2 m
OP2.SKYLINE.TR	Garnitură profil Skyline 2	Transparent	ml

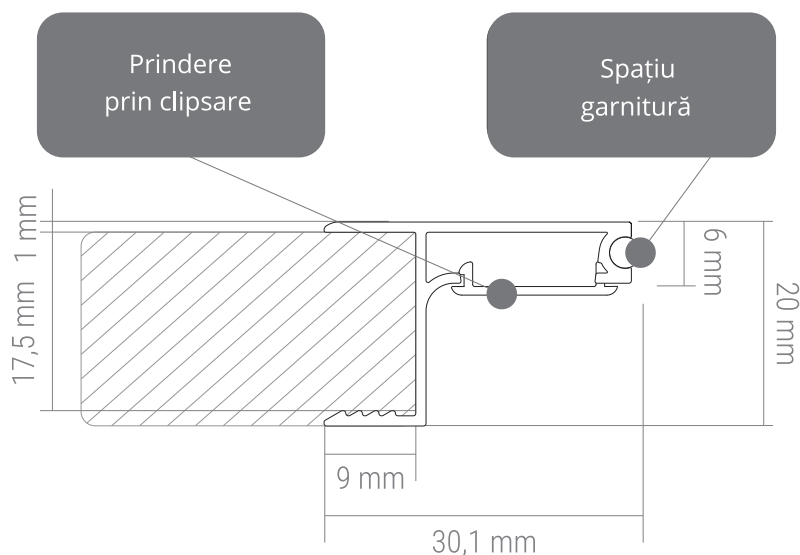

48. FLOOR LINE

Profil din aluminiu pentru bandă LED, finisaj aluminiu, bară 2 m, difuzor opac pentru prindere pe plintă din PAL

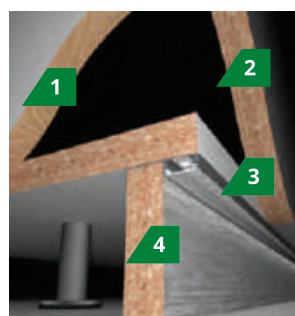

- 1 Profil corp
- 2 Front
- 3 Profil Floor Line
- 4 Plintă PAL

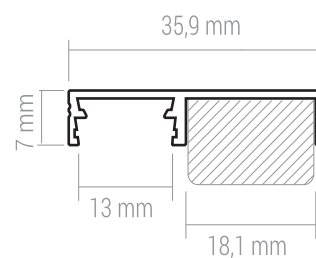

Cod	Produs	Finisaj / Difuzor	U.M.
FLOORLINE.AL.2M	Profil Floor Line	Aluminiu	Bară 2 m



10 PROFILE ALUMINIU PENTRU BANDĂ LED

49. DEOLINE

Profil architectural din aluminiu pentru panouri din rigips, cu difuzor, finisaj aluminiu

Cod	Produs	Finisaj / Difuzor	U.M.
DEOLINE.P.2M	Profil Deoline tip P	Aluminiu	Bară 2 m
DEOLINE.W.2M	Profil Deoline tip W	Aluminiu	Bară 2 m
DEOLINE.Z.2M	Profil Deoline tip Z	Aluminiu	Bară 2 m

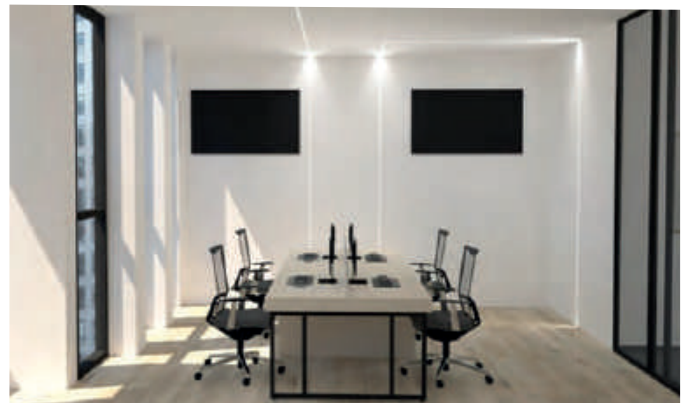
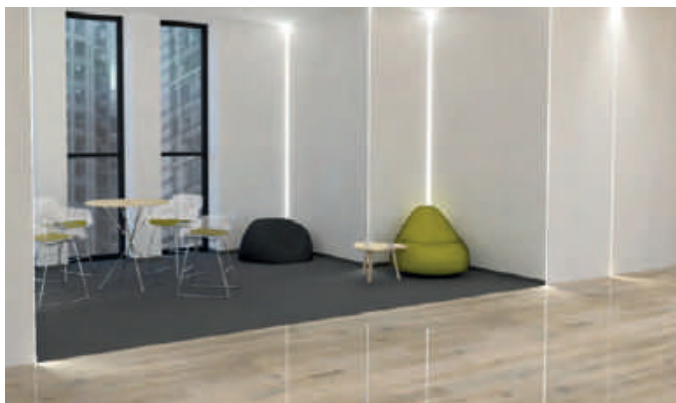
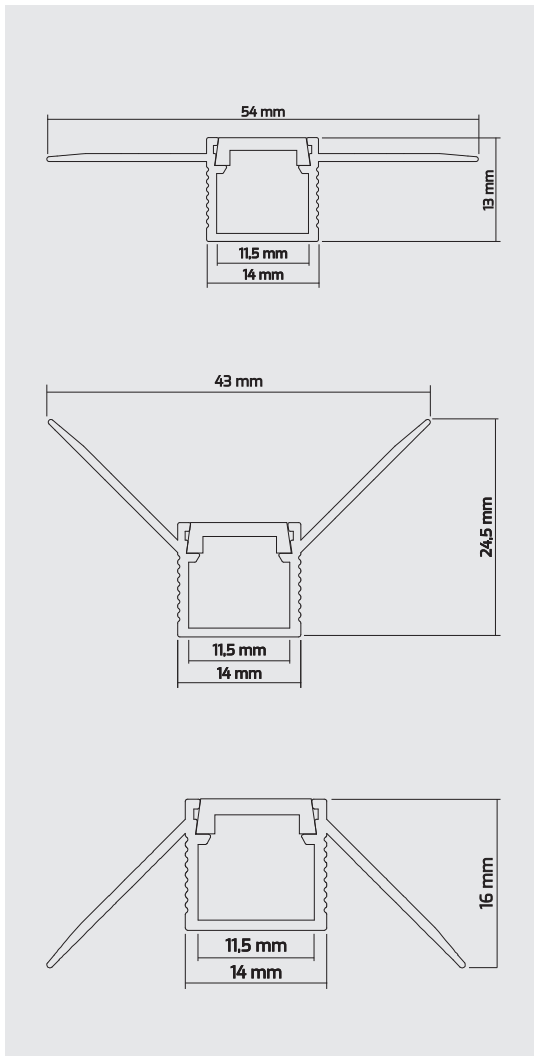

10 PROFILE PENTRU BANDĂ LED

50. TREND

Profil din plastic semitransparent alb pentru bandă LED, 2 m

Cod	Produs	Finisaj / Difuzor	U.M.
TREND.10.2M.OP	Profil Trend 10x10 mm	Alb semitransparent	Bară 2 m
OP2.Z.TREND.10	Capac capăt profil Trend 10x10 mm	Alb semitransparent	Buc.
TREND.15.2M.OP	Profil Trend 15x15 mm	Alb semitransparent	Bară 2 m
OP2.Z.TREND.15	Capac capăt profil Trend 15x15 mm	Alb semitransparent	Buc.

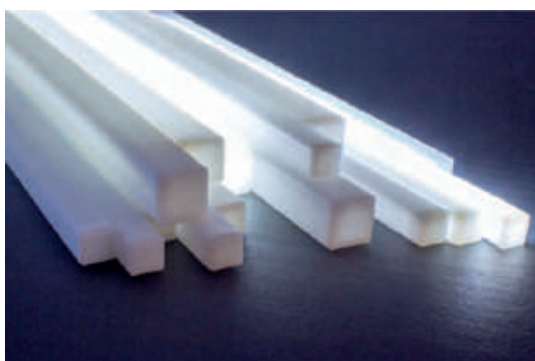
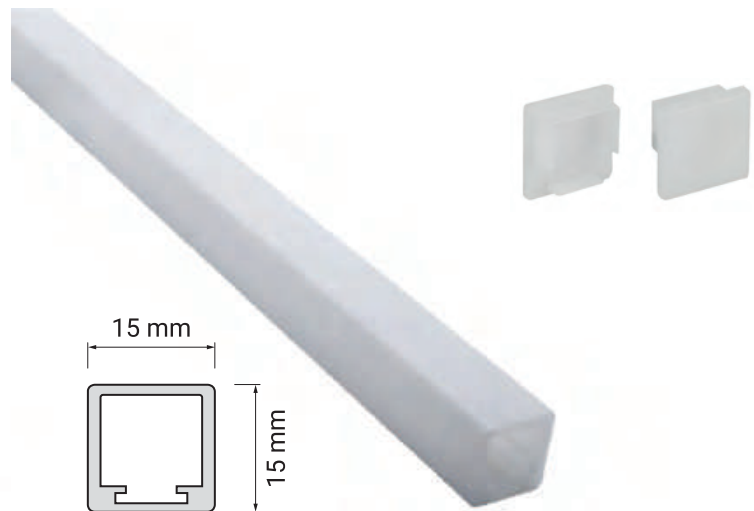
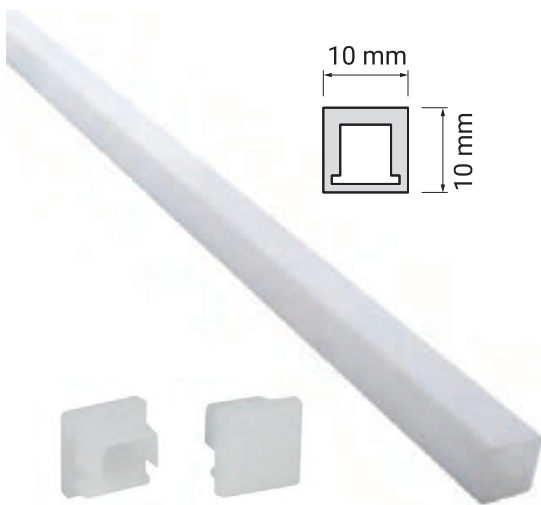

51. LED COB STRIP

Benzi LED cu lumina continuă

Cod	Produs	Număr LED-uri	IP	Lumină
LED.COB.512.8.30K	Bandă LED lumină continuă	512 LED/m	20	Caldă
LED.COB.512.8.40K	Bandă LED lumină continuă	512 LED/m	20	Neutră
LED.COB.512.8.60K	Bandă LED lumină continuă	512 LED/m	20	Rece

NOU ÎN PORTOFOLIU



Listă preț Benzi LED

- ▶ Benzi LED cu lumina caldă, rece, neutră
- ▶ Densitatea mare de diode electroluminiscente creează efectul unui flux continuu de lumină
- ▶ **Informații pentru 0,5 m de bandă:**
256 LED, 5,5W, 510 lm, Ip20
- ▶ **Informații pentru 1 m de bandă:**
512 LED, 11W, 1020 lm, Ip20
- ▶ Lungime bandă: 5 m; lățime: 8 mm

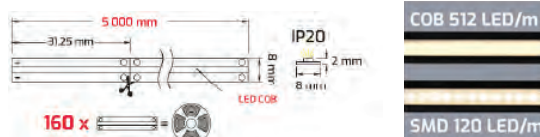

12V DC	max 5,5W	CRI ≥80	LED	IP20
HG ECO	30 000 h	>15 000	DIMMABLE	RoHS

IMPORTANT! Raza minimă de îndoire este de 12 mm.

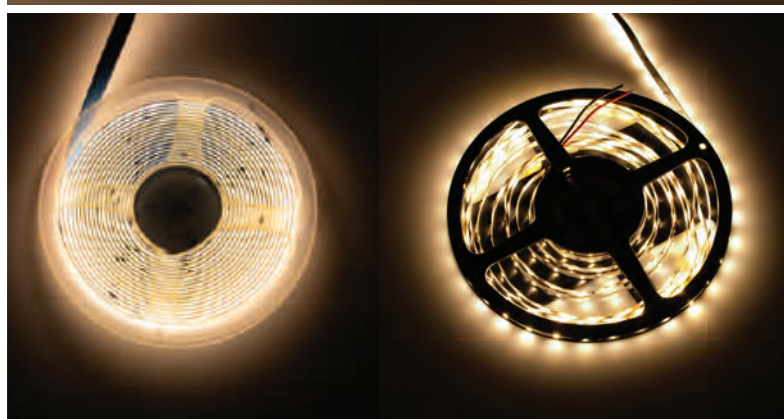

52. BLACK BANDĂ LED NEAGRĂ

Bandă cu 300 de LED-uri, premium, neagră

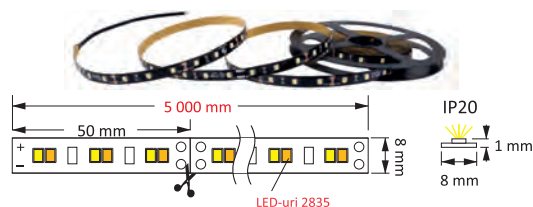

Cod	Tip LED	Nr. LED-uri	IP	W	Lumină
LED.2835.300.20.30K.03C	2835	300	20	30	Caldă
LED.2835.300.20.40K.03C	2835	300	20	30	Neutră
LED.2835.300.20.60K.03C	2835	300	20	30	Rece

Date tehnice



Lumină/Luminozitate (lm)



53. BIKOLOR BANDĂ LED BICOLORĂ

Bandă cu 600 de LED-uri, premium, cu lumină caldă și rece



Cod	Tip LED	Nr. LED-uri	IP	W	Lumină
LED BIKOLOR.2835.20.30K.60K	2835	600	20	30	Caldă + Rece

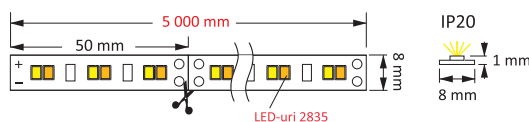

Date tehnice



Lumină



54. SNAKE BANDĂ LED FLEXIBILĂ

Bandă cu 300 de LED-uri, premium



Cod	Tip LED	Nr. LED-uri	IP	W	Lumină
LED SNAKE.2835.20.30K	2835	300	20	30	Caldă
LED SNAKE.2835.20.40K	2835	300	20	30	Neutră
LED SNAKE.2835.20.60K	2835	300	20	30	Rece

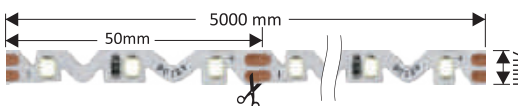

Date tehnice



Lumină/Luminozitate (lm)



55. BANDĂ LED 50M

Bandă cu 3.000 de LED-uri, premium

ATENȚIE! Nu conectați benzi cu lungimi mai mari de 5 m.

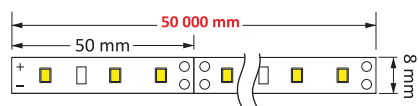

Cod	Tip LED	Nr. LED-uri	IP	W	Lumină
LED.2835.50M.20.30K	2835	3000	10	10	Caldă
LED.2835.50M.20.40K	2835	3000	10	10	Neutră
LED.2835.50M.20.60K	2835	3000	10	10	Rece

IP20 *Putere maximă pentru 1 metru de bandă LED.

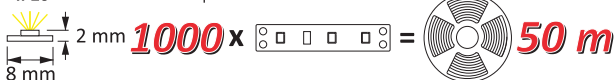

Date tehnice



Lumină/Luminozitate



56. BANDĂ LED 2835, IP 45 SAU IP 20, 300 LED

Bandă cu sau fără gel, 300 led-uri 2835 premium



30W

Cod	Tip LED	Nr. LED-uri	IP	W	Lumină
LED.2835.300.45.30K	2835	300	45	30	Caldă
LED.2835.300.45.40K	2835	300	45	30	Neutră
LED.2835.300.45.60K	2835	300	45	30	Rece
LED.2835.300.20.30K	2835	300	20	30	Caldă
LED.2835.300.20.40K	2835	300	20	30	Neutră
LED.2835.300.20.60K	2835	300	20	30	Rece

Date tehnice



Lumină/Luminozitate (lm)

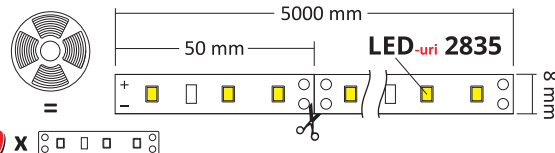

100 x

57. BANDĂ LED 2835, IP 20, 600 LED

Bandă fără gel, 600 led-uri 2835 premium



60W

Cod	Tip LED	Nr. LED-uri	IP	W	Lumină
LED.2835.600.20.30K	2835	600	20	60	Caldă
LED.2835.600.20.40K	2835	600	20	60	Neutră
LED.2835.600.20.60K	2835	600	20	60	Rece

Date tehnice



Lumină/Luminozitate (lm)

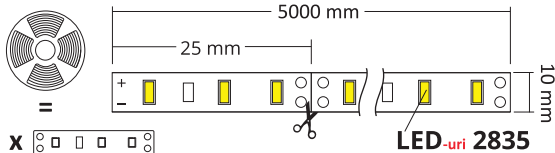

200 x

58. BANDĂ LED 3014, IP 20, 1.200 LED

Bandă fără gel, 1.200 led-uri 3014 premium



90W

Cod	Tip LED	Nr. LED-uri	IP	W	Lumină
LED.3014.1200.20.30K	3014	1200	20	90	Caldă
LED.3014.1200.20.40K	3014	1200	20	90	Neutră
LED.3014.1200.20.60K	3014	1200	20	90	Rece

Date tehnice



Lumină/Luminozitate (lm)

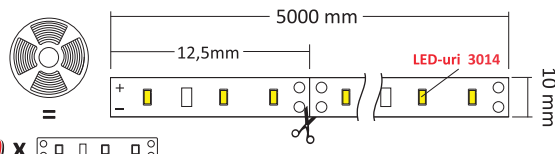

400 x



59. BANDĂ LED 5630, IP 45 SAU IP 20, 300 LED

Bandă cu sau fără gel, 300 led-uri 5630 premium



80W

Cod	Tip LED	Nr. LED-uri	IP	W	Lumină
LED.5630.300.45.30K	5630	300	45	80	Caldă
LED.5630.300.45.60K	5630	300	45	80	Rece
LED.5630.300.20.30K	5630	300	20	80	Caldă
LED.5630.300.20.60K	5630	300	20	80	Rece

Date tehnice



Lumină/Luminozitate (lm)

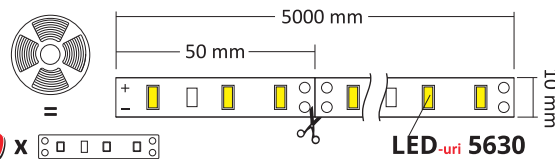

60. BANDĂ LED RGB 5050, IP 45 SAU IP 20, 150 LED

Bandă cu sau fără gel, cu 150 LED-uri RGB 5050



37,5W

Cod	Tip LED	Nr. LED-uri	IP	W	Lumină
LED.5050.150.45.RGB	5050	150	45	37,5	RGB
LED.5050.150.20.RGB	5050	150	20	37,5	RGB

Date tehnice

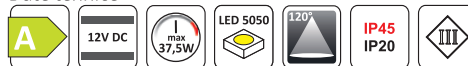

Lumină/Luminozitate (lm)

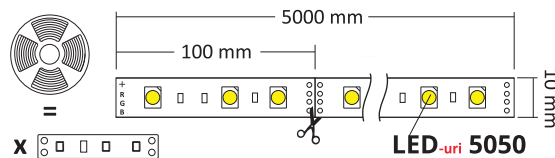

61. BANDĂ LED RGB 5050, IP 45 SAU IP 20, 300 LED

Bandă cu sau fără gel, cu 300 LED-uri RGB 5050



75W

Cod	Tip LED	Nr. LED-uri	IP	W	Lumină
LED.5050.300.45.RGB	5050	300	45	75	RGB
LED.5050.300.20.RGB	5050	300	20	75	RGB

Date tehnice

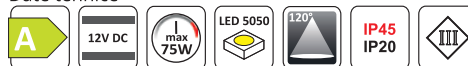

Lumină/Luminozitate (lm)

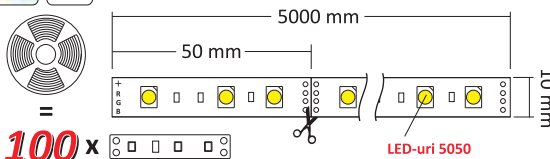

Listă preț
Benzi LED



62. BANDĂ LED RGB 5050, IP 45 SAU IP 20 - SET 1

Set bandă cu sau fără gel, 150 led-uri RGB, controler și telecomandă

Setul conține:

- ▶ 1 x bandă LED RGB 5 m
- ▶ 1x controler RGB IR (infraroșu)
- ▶ 1 x telecomandă
- ▶ 1 x transformator 38W



Cod	Tip LED	Nr. LED-uri	IP	W	Lumină
SET1.RGB.45	5050	150	45	37,5	RGB
SET1.RGB.20	5050	150	20	37,5	RGB

Date tehnice



Lumină/Luminozitate (lm)

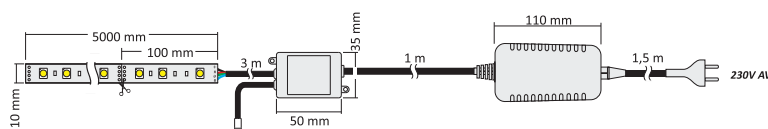

63. BANDĂ LED RGB 5050, IP 45 SAU IP 20 - SET 2

Set bandă cu sau fără gel, 150 led-uri RGB, controler și telecomandă

Setul conține:

- ▶ 1 x bandă LED RGB 5 m
- ▶ 1x controler RGB RF (radiofrecvență)
- ▶ 1 x telecomandă
- ▶ 1 x transformator 38W



Cod	Tip LED	Nr. LED-uri	IP	W	Lumină
SET2.RGB.45	5050	150	45	37,5	RGB
SET2.RGB.20	5050	150	20	37,5	RGB

Date tehnice



Lumină/Luminozitate (lm)

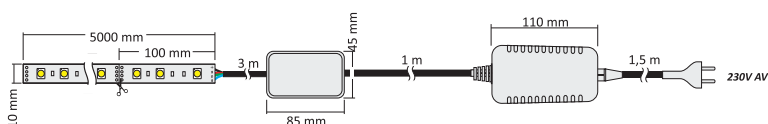

64. BANDĂ LED RGB 5050, IP 45 SAU IP 20 - SET 3

Set bandă cu sau fără gel, 150 led-uri RGB, controler și telecomandă

Setul conține:

- ▶ 1 x bandă LED RGB 5 m
- ▶ 1x controler RGB RF (radiofrecvență)
- ▶ 1 x telecomandă
- ▶ 1 x transformator 38W



Cod	Tip LED	Nr. LED-uri	IP	W	Lumină
SET3.RGB.45	5050	150	45	37,5	RGB
SET3.RGB.20	5050	150	20	37,5	RGB

Date tehnice



Lumină/Luminozitate (lm)

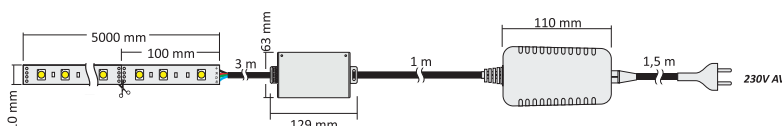

65. SET BANDĂ LED ȘI COMUTATOR

Set cu bandă LED 2835 și comutator XC60



Cod	Tip LED	Nr. LED-uri	IP	W	Lumină
LED.2835.300.20.30K.XC	2835	300	20	30	Caldă
LED.2835.300.20.40K.XC	2835	300	20	30	Neutră
LED.2835.300.20.60K.XC	2835	300	20	30	Rece

Date tehnice bandă LED:



Date tehnice comutator:

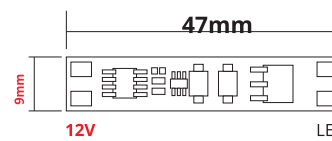
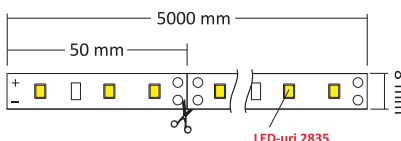

Lumină/Luminozitate (lm)



66. BLIX

Set cu bandă LED, senzor, baterie și cablu de alimentare pentru dulapuri



Sistemul conține:

- ▶ Bandă cu LED-uri, 1 m + cablu cu mufă Jack, 1 m
- ▶ Cablu cu USB și Mini USB, 25 cm
- ▶ Senzor de mișcare cu baterie, încărcare cu USB

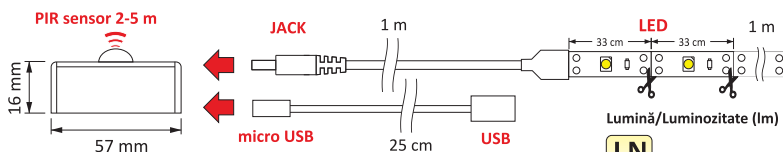
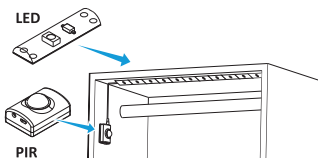

Date tehnice

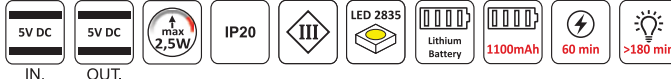

Bandă LED

Cablu USB / Mini USB

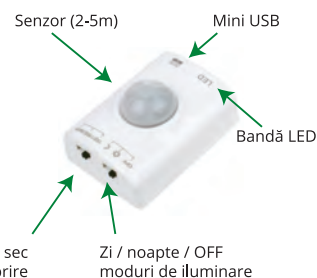

14 sec, 130 sec, 380 sec
reglarea timpului până la oprire

67. MICRO CONECTOR FĂRĂ FIRE PENTRU 2 BENZI LED 8 SAU 10 MM



Cod	mm
CONEC.1	8
CONEC.2	10

68. MICRO CONECTOR PENTRU BANDĂ LED 8 SAU 10 MM, CABLU 2 M, CAPETE GALVANIZATE

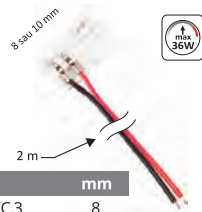

Cod	mm
CONEC.3	8
CONEC.4	10

69. MICRO CONECTOR PENTRU BANDĂ LED 8 MM, CABLU 2 M, CU MINIMUFĂ

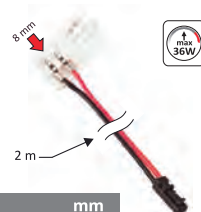

Cod	mm
CONEC.5	8

70. MICRO CONECTOR PENTRU BANDĂ LED 8 MM, CABLU 0.15 M, CU MINIMUFĂ LA AMBELE CAPETE

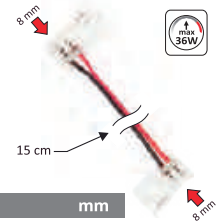

Cod	mm
CONEC.6	8

Micro conectori pentru profilul Line XL

71. MICRO CONECTOR FĂRĂ FIRE PENTRU 2 BENZI LED 8 MM



Cod	mm
CONEC.8.1	8

72. MICRO CONECTOR PENTRU BANDĂ LED 8 MM, CABLU 2 M, CAPETE GALVANIZATE

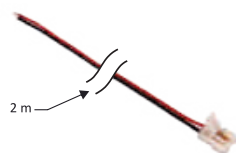

Cod	mm
CONEC.8.3	8

73. MICRO CONECTOR PENTRU BANDĂ LED 8 MM, CABLU 2 M, CU MINIMUFĂ

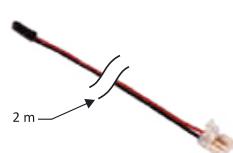

Cod	mm
CONEC.8.5	8

74. MICRO CONECTOR PENTRU BANDĂ LED 8 MM, CABLU 0.15 M, CU MINIMUFĂ LA AMBELE CAPETE



Cod	mm
CONEC.8.6	8

75. MICRO CONECTOR FĂRĂ FIRE PENTRU 2 BENZI LED RGB 10 MM



Cod	mm
CONEC.7	10

76. MICRO CONECTOR PENTRU BANDĂ LED RGB 10MM, CABLU 2M, CAPETE GALVANIZATE

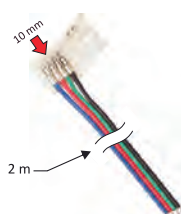

Cod	mm
CONEC.8	10

77. MICRO CONECTOR ÎN "L" FĂRĂ FIRE PENTRU 2 BENZI LED 8 MM



Cod	mm
CONEC.L.1	8

78. MICRO CONECTOR ÎN "L" FĂRĂ FIRE PENTRU 2 BENZI LED 10 MM



Cod	mm
CONEC.L.2	10

79. MICRO CONECTOR ÎN "L" FĂRĂ FIRE PENTRU 2 BENZI LED RGB 10 MM



Cod	mm
CONEC.L.3	10



Listă preț
Accesorii pentru benzi LED

80. MINIDISTRIBUTOR CU 6 IEȘIRI, CABLU DE 2 M, CAPETE GALVANIZATE

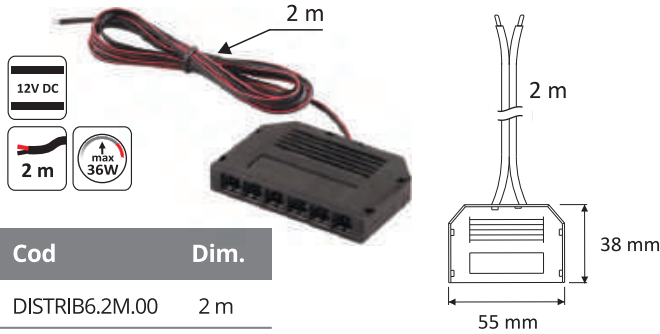

Cod	Dim.
DISTRIB6.2M.00	2 m

81. MINIDISTRIBUTOR CU 3 IEȘIRI, CABLU DE 2 M, CAPETE GALVANIZATE

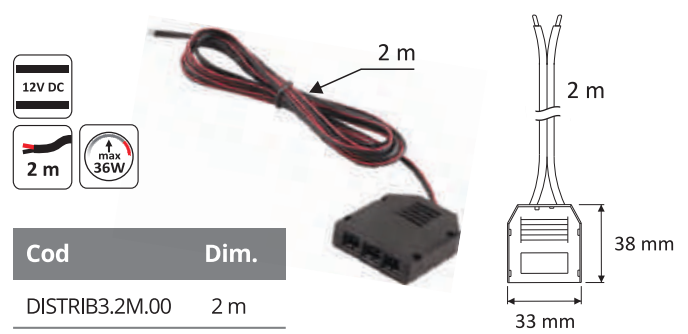

Cod	Dim.
DISTRIB3.2M.00	2 m

82. MINIDISTRIBUTOR CU 6 IEȘIRI, CABLU DE 2 M SAU 15CM, MINIMUFĂ

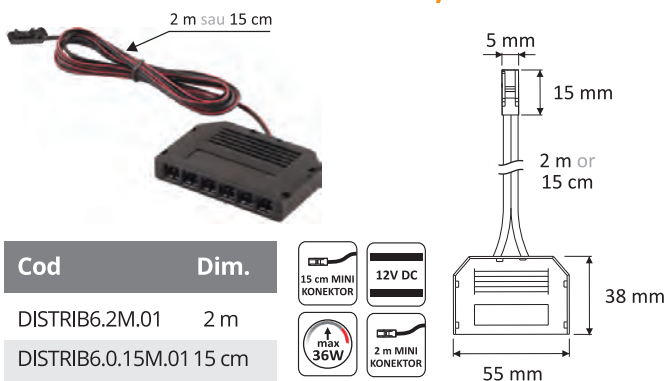

Cod	Dim.
DISTRIB6.2M.01	2 m
DISTRIB6.0.15M.01	15 cm

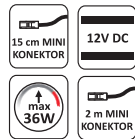

83. MINIDISTRIBUTOR CU 3 IEȘIRI, CABLU DE 2 M SAU 15CM, MINIMUFĂ

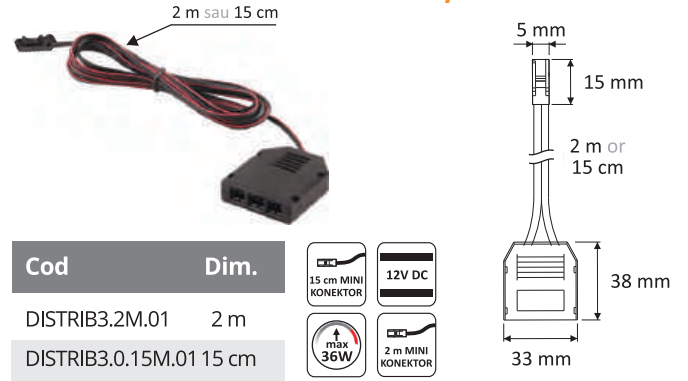

Cod	Dim.
DISTRIB3.2M.01	2 m
DISTRIB3.0.15M.01	15 cm

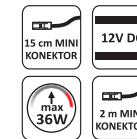

84. MINIDISTRIBUTOR RGB CU 9 IEȘIRI, CABLU DE 2 M ȘI MINIMUFĂ

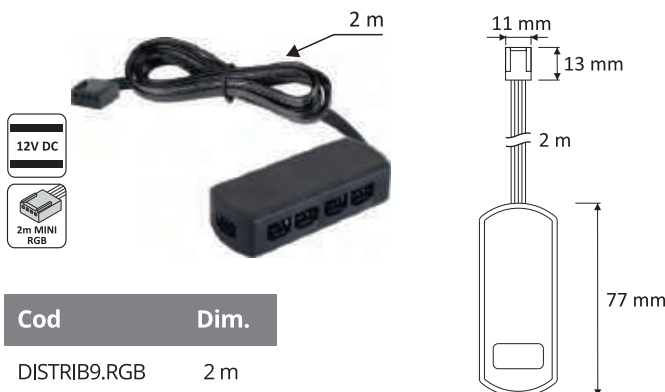

Cod	Dim.
DISTRIB9.RGB	2 m

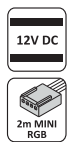

85. CABLU EXTENSIE DE 2 M CU MINIMUFĂ LA UN CAPĂT ȘI FIRE SAU MINIMUFĂ LA CELĂLALT CAPĂT

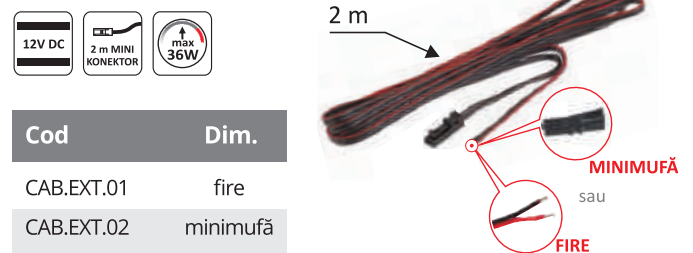

Cod	Dim.
CAB.EXT.01	fire
CAB.EXT.02	minimufă



Cod	Dim.
JACK.2M	2 m

86. CABLU EXTENSIE DE 2 M PENTRU LED RGB CU MUFĂ JACK

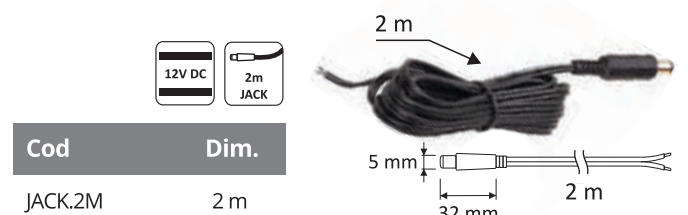

86. TRANSFORMATOR 15W CU 4 MINIMUFE ÎNCORPORATE

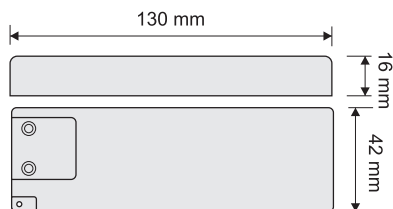

Cod	Putere (W)	T max (°C)	L (mm)	H (mm)	↑ (mm)
TRALD.15W	15	75	130	16	42

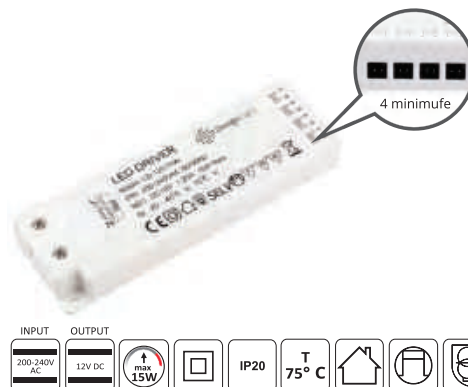

87. TRANSFORMATOR 30W CU 6 MINIMUFE ÎNCORPORATE

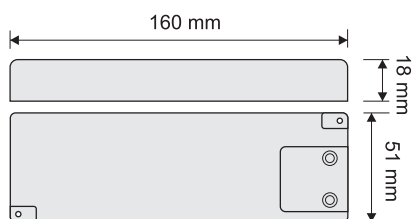

Cod	Putere (W)	T max (°C)	L (mm)	H (mm)	↑ (mm)
TRALD.30W	30	75	160	18	51

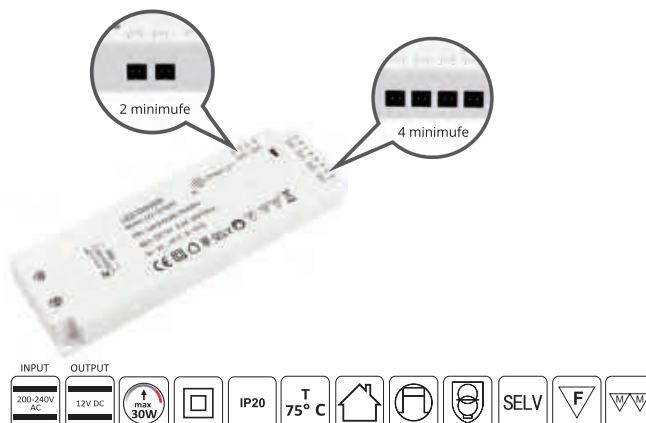

88. TRANSFORMATOR 60W CU 6 MINIMUFE ÎNCORPORATE

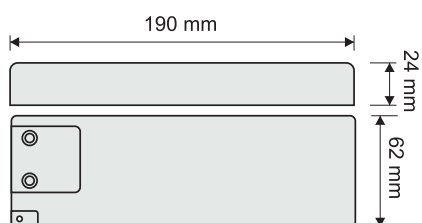

Cod	Putere (W)	T max (°C)	L (mm)	H (mm)	↑ (mm)
TRALD.60W	60	80	190	24	62

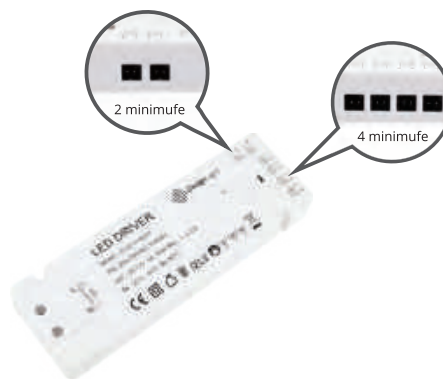

89. TRANSFORMATOR CARCASĂ METALICĂ

Cod	Putere (W)	T max (°C)	L (mm)	H (mm)	↑ (mm)
TRAM.75W	75	80	160	37	97
TRAM.100W	100	80	200	39	98
TRAM.150W	150	80	200	50	110
TRAM.200W	200	80	200	50	110



Listă preț
Accesorii
soluții
de iluminat



90. TRANSFORMATOR SLIM PREMIUM

Cod	Putere (W)	T max (°C)	L (mm)	H (mm)	î (mm)
TRA.S.6W	6	80	99	11	46
TRA.S.15W	15	80	102	16	35
TRA.S.30W	30	80	156	17	51
TRA.S.50W	50	80	160	17	58
TRA.S.75W	75	80	201	31	63
TRA.S.100W	100	80	180	31	66
TRA.S.132W	132	80	180	31	66
TRA.S.180W	180	80	195	31	66

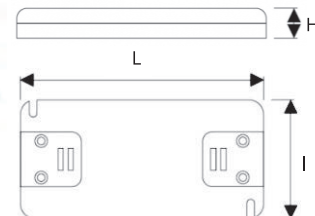

Date tehnice:

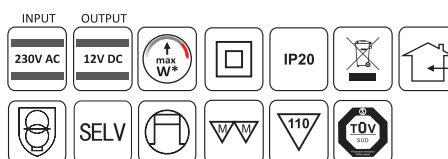

91. TRANSFORMATOR STANDARD PLUS

Cod	Putere (W)	T max (°C)	L (mm)	H (mm)	î (mm)
TRA.SP.7W	7	80	86	22	35
TRA.SP.12W	12	80	106	23	43
TRA.SP.16W	16	80	106	23	43
TRA.SP.24W	24	80	140	25	47
TRA.SP.33W	33	80	140	25	47
TRA.SP.54W	54	80	152	32	59
TRA.SP.65W	65	80	152	32	59
TRA.SP.80W	80	80	156	35	63
TRA.SP.150W	150	85	205	35	71
TRA.SP.200W	200	85	205	35	71

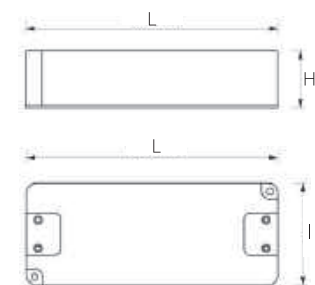

Date tehnice:

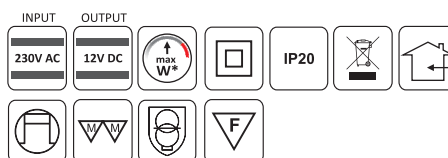

92. TRANSFORMATOR CU CABLURI: 2 M CU ȘTECHER, 2 M CU MINIMUFĂ

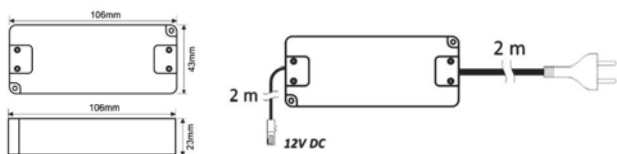

Cod	Putere (W)	T max (°C)	L (mm)	H (mm)	î (mm)
SET.TRA.L.16W	16	80	106	23	43
SET.TRA.L.33W	33	80	140	25	47



Date tehnice:

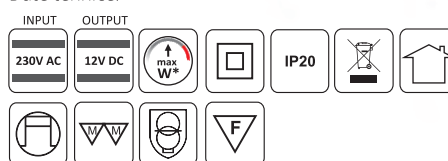

93. TRANSFORMATOR SLIM PREMIUM, IP 44

Cod	Putere (W)	T max (°C)	L (mm)	H (mm)	↑ (mm)
TRAS.IP44.15W	15	80	130	15	41
TRAS.IP44.30W	30	85	158	17	51
TRAS.IP44.60W	60	90	167	18	58
TRAS.IP44.100W	100	90	167	18	58

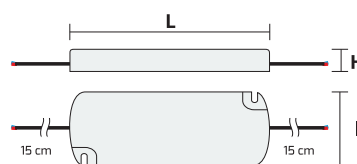

Date tehnice:



94. CONECTOR IZOLATOR IP 54

Cod	Putere (W)	T max (°C)	L (mm)	H (mm)	↑ (mm)
IZOLAT.IP54	17,5	-	60	15	27

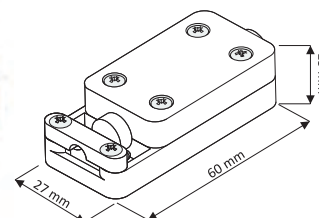

Date tehnice:



95. TRANSFORMATOR CU CABLURI, MUFĂ JACK SAU MINIMUFĂ

Cod	Mufă	Putere (W)	L (mm)	H (mm)	↑ (mm)
SET.TRA.38W.JACK	Jack	38	110	33	49
SET.TRA.38W	Minimufă	38	110	33	49

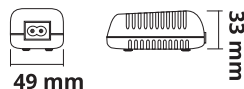
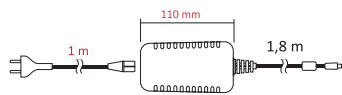

Date tehnice:



96. TRANSFORMATOR PENTRU LED-URI, RGB CU MUFĂ JACK

Cod	Putere (W)
SET.TRA.18W.JACK	18

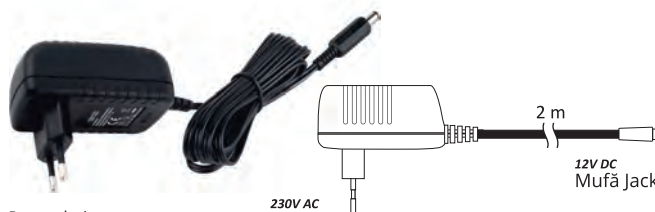

Date tehnice:



97. SELI - SET CU TELECOMANDĂ ȘI CONTROLER RF

Cu ajutorul acestei soluții puteți controla, de la distanță toate sistemele de iluminat cu LED. Telecomanda Seli este dotată cu funcție ON/OFF și dimmer și are o rază de acțiune de până la 30 de metri. Telecomanda este disponibilă în două finisaje: alb și negru.

Cod	Finisaj
SET.SELI.A	Alb
SET.SELI.N	Negru

Date tehnice:



98. CONTROLER CU ÎNTRERUPĂTOR RF - 3 NIVELE DE INTENSITATE

Cu ajutorul setului cu întrerupător și controler, controlați sistemele de iluminat cu LED monocrome. Întrerupătorul poate fi acționat de la o distanță de până la 30 de metri de controler.

Cod	Descriere
STER.KLA	Controler cu întrerupător

**Listă preț
Accesorii
soluții
de iluminat**

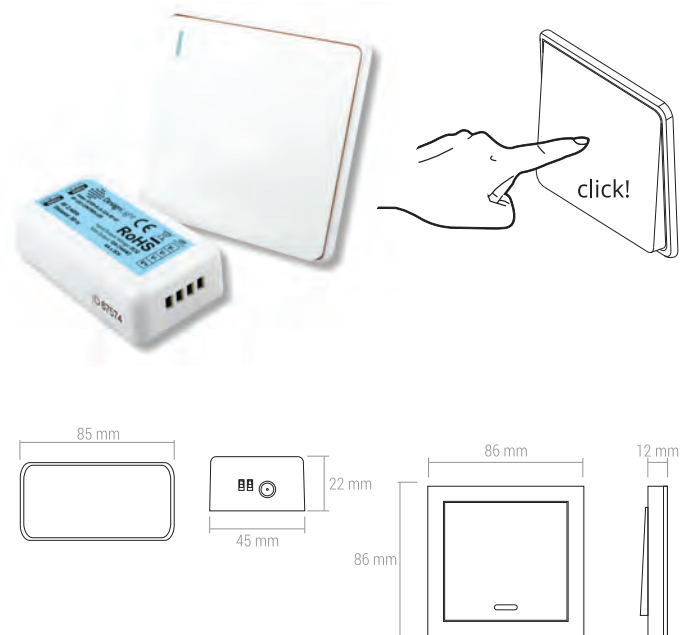
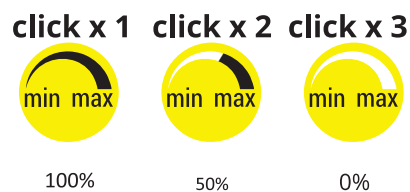

Date tehnice:



230V AC

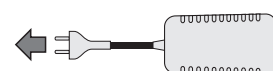

12V DC

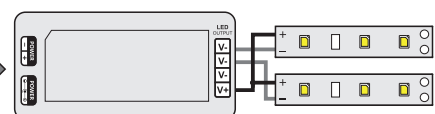

12V DC
max. 3 canale

99. DELI - SET CU SENZOR PIR ȘI CONTROLER RF

Setul Deli este utilizat frecvent în dulapuri cu mai multe uși. Cu ajutorul senzorului PIR, lumina se aprinde când este detectată mișcare în la distanță de aproximativ 1,5 m și se stinge automat după 40 de secunde, dacă nu detectează altă mișcare. Controlerul RF poate susține până la 4 senzori, disponibili în două finisaje: alb și negru.

Cod	Descriere	Finisaj
SET.DELI.N	Controler RF și senzor PIR	Negru
SET.DELI.A	Controler RF și senzor PIR	Alb
DELI.SENS.N	Senzor PIR	Negru
DELI.SENS.A	Senzor PIR	Alb

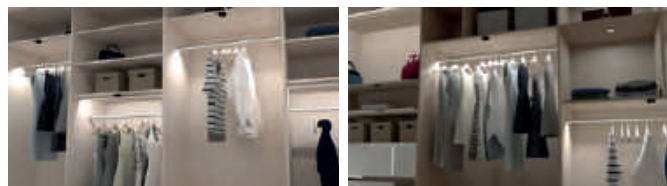

Scanează codul QR și vezi cum funcționează.

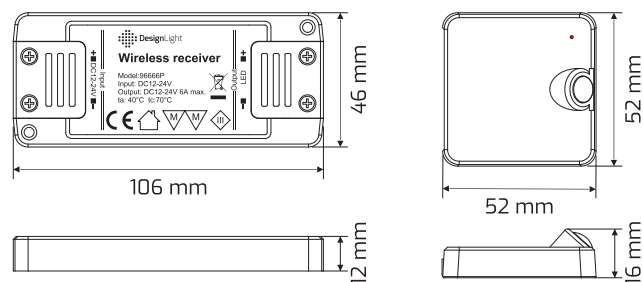

Date tehnice:



100. CONTROLER/ROUTER WI-FI

Dispozitivul vă permite să controlați sistemele de iluminat cu LED prin Wi-Fi, folosind un smartphone sau o tabletă, după instalarea aplicației compatibile Android sau iOS. Funcționează împreună cu cele două controlere RF din oferta noastră.



Cod	Descriere
STER.RGB.WIFI	Controler

Date tehnice:

- ▶ Alimentare: 5V 500 mA
- ▶ Comenzi: Wi-Fi -> 2.4 GHz Radio
- ▶ Dimensiuni: 90 mm x 68 mm x 16 mm



Scanează codul QR și vezi cum funcționează.

101. CONTROLER BICOLOR

Controlerul este acționat de telecomanda RF (radio-frecvență) pe o rază de 30 m. Este destinat benzii LED Bikolor și vă permite schimbarea luminii din caldă în rece. Alimentare DC 12V-24V, care nu depășește un consum total de curent de maxim 10A.

Cod	Descriere
CONT.LED.BIKOLOR	Controler

Date tehnice:

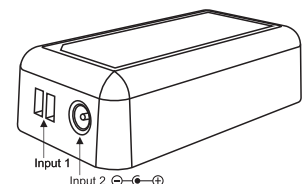

102. TELECOMANDĂ PENTRU SISTEM DE ILUMINAT RGB, 4 ZONE

Telecomanda controlează 4 zone iluminate cu LED RGB. Este folosită pentru a controla iluminatul și programele de iluminat în 4 zone independente.

Cod	Descriere
TELEC.RF.4C.RGB	Telecomandă
SUP.TELEC	Suport

* Bateriile nu sunt incluse.

** Suportul pentru telecomanda este disponibil separat.

Date tehnice:



103. CONTROLER RF LED RGB

Controlerul este acționat de telecomanda RF (radio-frecvență) pe o rază de 30 m. Este destinat corpurilor de iluminat cu LED RGB alimentate de sursă 12V DC, care nu depășește un consum total de curent de 12A.

Cod	Descriere
CONT.LED.RGB	Controler

Date tehnice:

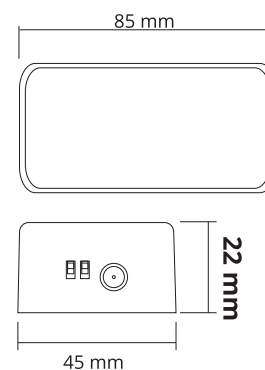

104. TELECOMANDĂ PENTRU SISTEM DE ILUMINAT CU LED, 4 ZONE

Telecomanda controlează 4 zone iluminate cu LED. Este folosită pentru a controla iluminatul și programele de iluminat în 4 zone independente.

Cod	Descriere
TELEC.RF.4C	Telecomandă
SUP.TELEC	Suport
* Bateriile nu sunt incluse. ** Suportul pentru telecomanda este disponibil separat.	

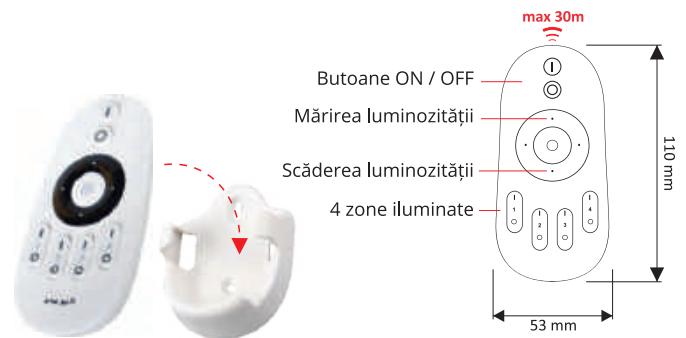

Date tehnice:



105. CONTROLLER RF LED, 4 ZONE

Controllerul este utilizat pentru configurarea zonelor iluminate. Un controller susține 1 zonă și trebuie să fie conectat la sursa de energie LED. Controllerul este acționat de telecomanda RF 4 zone.

Cod	Descriere
CONT.LED	Controller



Date tehnice:

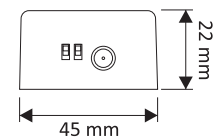
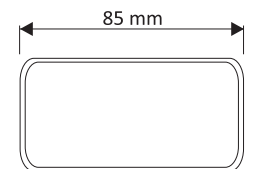

106. TELECOMANDĂ IR ȘI CONTROLLER PENTRU SCHIMBAREA CULORILOR

Controllerul este acționat de telecomanda IR (infraroșu). Este destinat corpurilor de iluminat cu LED RGB alimentate de sursă 12V DC, care nu depășește un consum total de curent de 12A.

Cod	Descriere
TELEC.IR	Telecomandă și controller

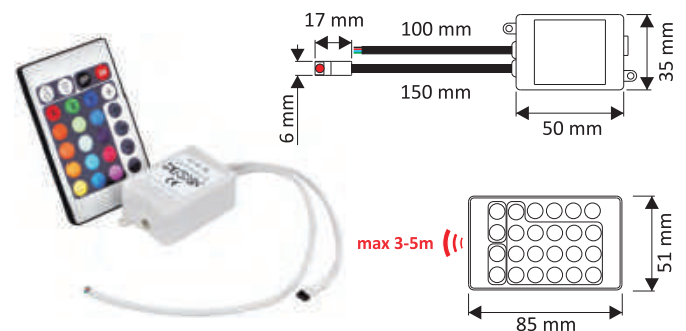

107. TELECOMANDĂ ȘI CONTROLLER, 1 ZONĂ DE ACȚIUNE

Controllerul este acționat de telecomanda RF (radio-frecvență) pe o rază de 30 m. Este destinat corpurilor de iluminat cu LED RGB alimentate de sursă 12V DC, care nu depășește un consum total de curent de 12A.

Cod	Descriere
TELEC.RF.1C.RGB	Telecomandă și controller



Date tehnice:

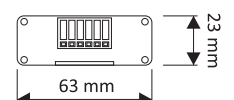
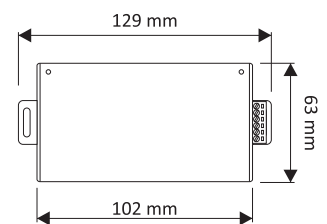

108. ANGLE

Comutator ON/OFF cu acționare prin atingere și dimmer. Comutator modern cu acționare prin atingere. O atingere scurtă pe întreaga suprafață a comutatorului aprinde/stinge lumina. O atingere prelungită activează dimmer-ul.

Date tehnice:



Cod

ANGLE

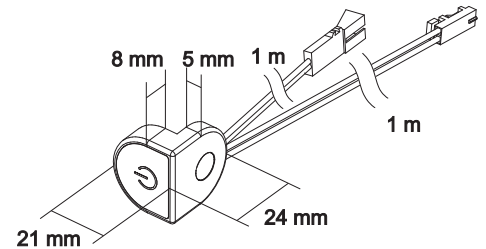

109. DOOR

Comutator cu senzor pentru uși batante sau glisante. Comutator modern cu infraroșu creat pentru mobilier cu uși glisante sau batante. Funcționează cu sisteme LED de până la 36W, cu o rază de acțiune de max. 15 cm.

Date tehnice:



Cod

DOOR

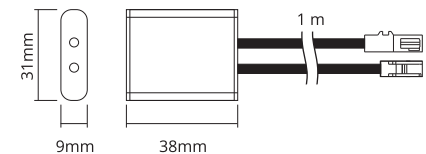
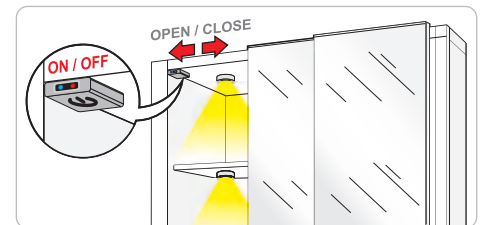

110. MOVE

Comutator ON/OFF cu senzor de proximitate. Comutator modern cu infraroșu creat pentru mobilier sisteme de iluminat cu LED de până la 36W. Prima mișcare (max. 15 cm) aprinde lumina. A doua mișcare stinge lumina.

Date tehnice:



Cod

MOVE

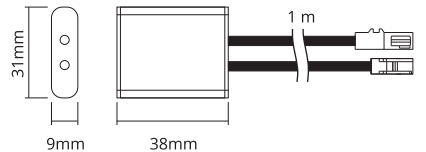
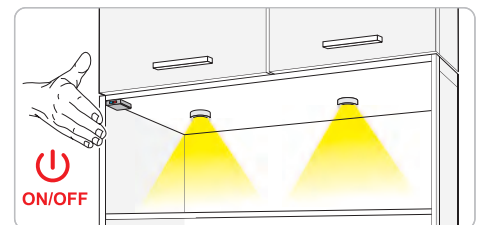

111. TOUCH

Comutator ON/OFF cu acționare prin atingere și dimmer. Comutator modern cu acționare prin atingere. O atingere scurtă pe întreaga suprafață a comutatorului aprinde/stinge lumina. O atingere prelungită activează dimmer-ul.

Date tehnice:



Cod

TOUCH

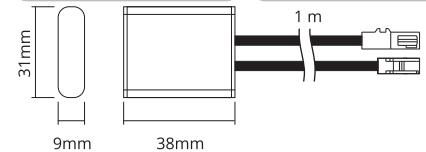
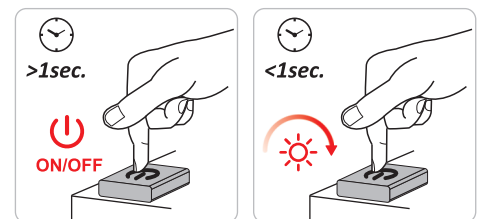

112. W01

Comutator mecanic cu dimmer și cu lumină albastră. O atingere scurtă aprinde sau stinge lumina, iar o atingere lungă reduce sau mărește intensitatea luminii.

Date tehnice:



Cod	Finisaj
W01.N	Negru
W01.A	Alb

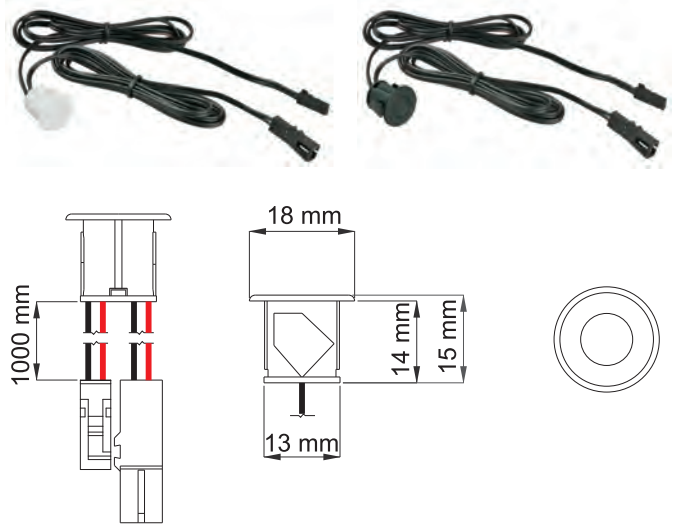

113. W02

Comutator mecanic cu dimmer și cu lumină albastră. O atingere scurtă aprinde sau stinge lumina, iar o atingere lungă reduce sau mărește intensitatea luminii.

Cod	Finisaj
W02.CH	Crom

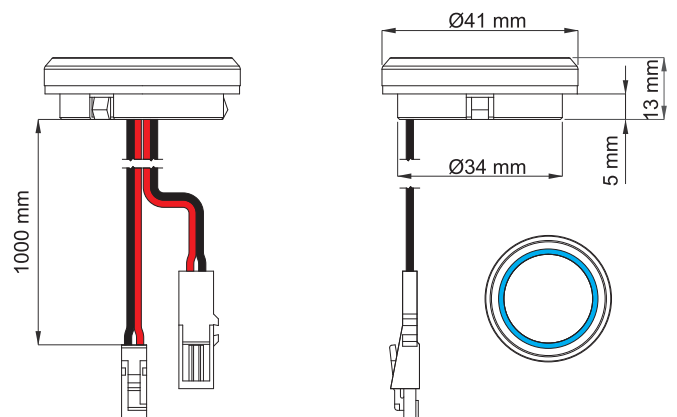

114. BUTTON

Comutator touch cu dimmer. Comutator cu activare prin atingere pentru corpuri de iluminat cu LED, cu funcție de dimmer.

Cod	Finisaj
BUTTON.A	Alb
BUTTON.N	Negru

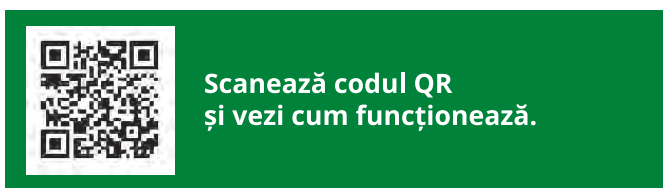
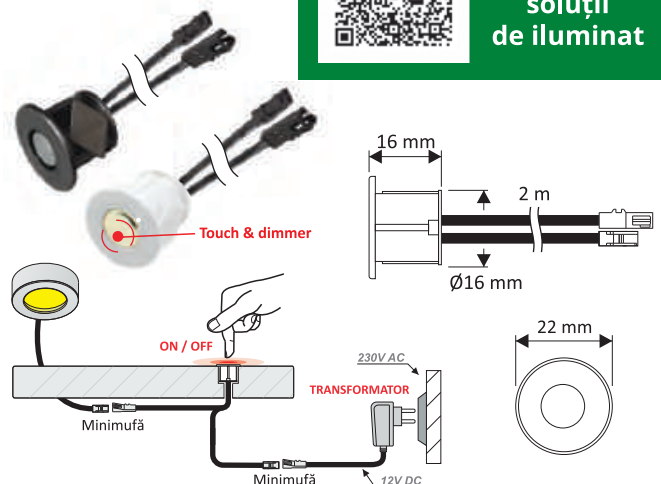

115. COMUTATOR DE PROXIMITATE IR (INFRAROȘU)

Aprinde și stinge corpurile de iluminat prin detectarea mișcării pe o rază de 35 mm și un unghi de 90 de grade.

Cod **Descriere**

SENSOR.500 Comutator

Date tehnice:

INPUT/OUTPUT

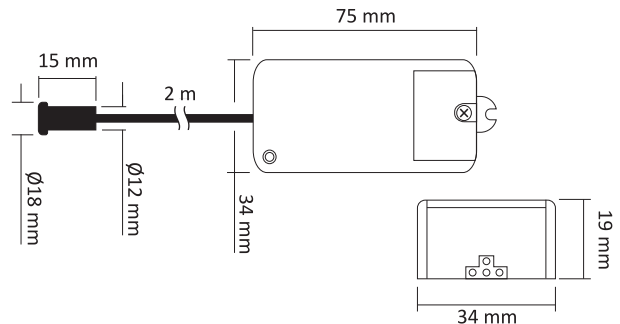

116. IRSO

Comutator universal cu senzor. Comutator cu mod de operare ajustabil. Modul bistabil - pentru uz general și modul monostabil - pentru dulapuri cu uși și sertare.

Date tehnice:

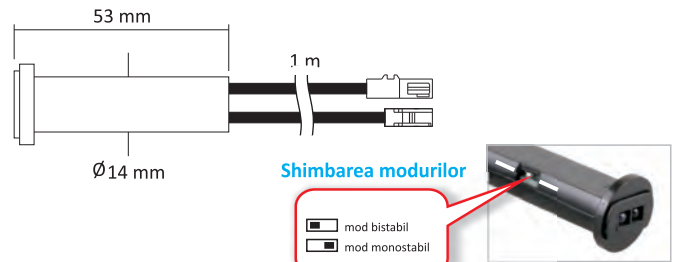

Scanează codul QR și vezi cum funcționează.



Cod	Finisaj
IRSO.A	Alb
IRSO.N	Negru

117. SUPORT PENTRU MONTAJUL COMUTATOARELOR IRSO

Cod **Finisaj**

SUP.IRSO.A Alb

SUP.IRSO.N Negru

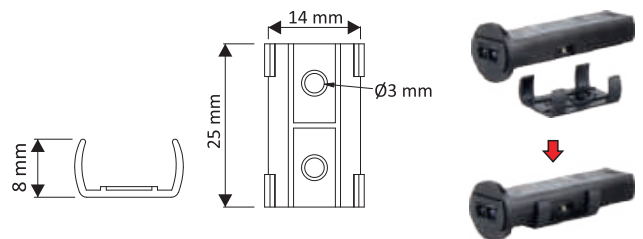

118. COMUTATOR UNIVERSAL CU SAU FĂRĂ FIRE

Cod **Finisaj**

CLICK.A.FIR Alb

CLICK.N.FIR Negru

CLICK.M.FIR Maro

CLICK.G.FIR Gri

Cod **Finisaj**

CLICK.A Alb

CLICK.N Negru

CLICK.M Maro

CLICK.G Gri

Date tehnice comutator fără fire:

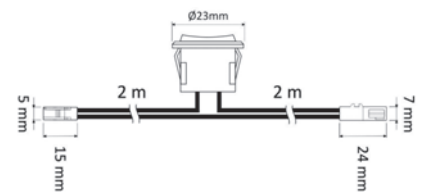
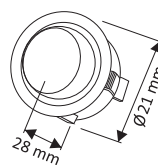
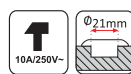

119. SC60

Comutator touch cu dimmer pentru profile. Comutator cu activare prin atingere și dimmer pentru profile din aluminiu. O atingere scurtă aprinde sau stinge lumina, iar o atingere lungă reduce sau mărește intensitatea luminii.

Compatibil cu profilele:
Line Mini, Inline Mini, Inline Mini XL, Corner Line

Date tehnice:



Cod: SC60

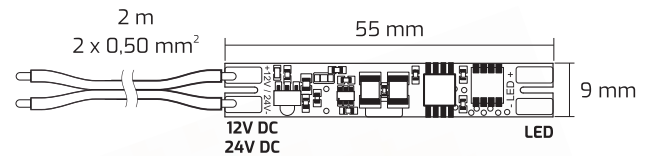

120. MASTER TOUCH

Comutator universal cu activare prin atingere. Comutator cu activare prin atingere pentru corpuri de iluminat cu LED. Compatibil cu toate corpurile de iluminat cu LED dotate cu minimufe.

Date tehnice:

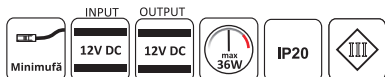

Cod: MASTER TOUCH

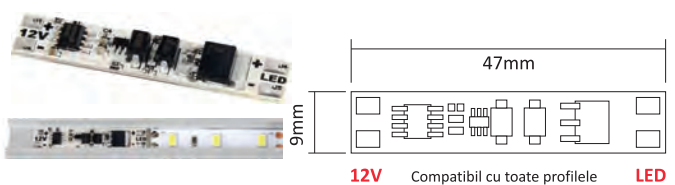
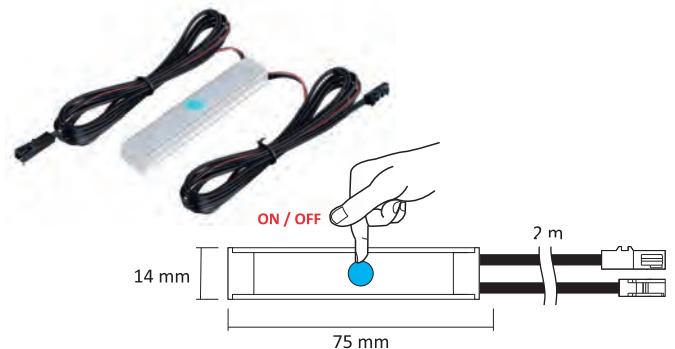

121. XC60

Comutator pentru profile cu LED. Comutatorul emite o lumină albastră care este aprinsă atunci când sistemul este conectat la sursa de energie.

Date tehnice:



Cod: XC60

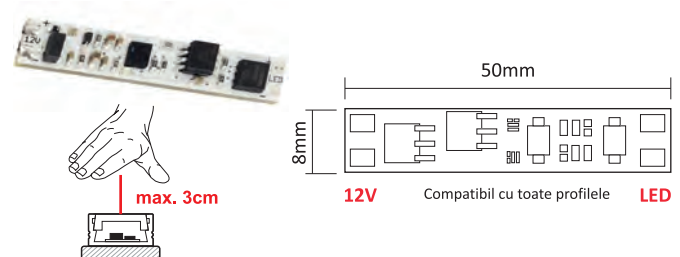

122. RUMMY

Comutator cu senzor de proximitate pentru profile cu LED. Comutatorul este activat de mișcarea la distanță de maxim 3 cm.

Date tehnice:



Cod: RUMMY

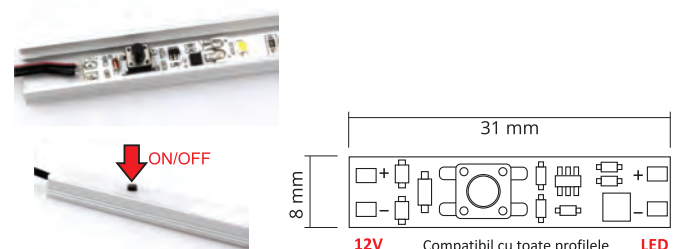

123. MS60

Comutator pentru profile cu LED. Sistemul are integrat un comutator mecanic. Atașați plăcuța de profil și găuriți difuzorul (4-5 mm diametru), astfel încât comutatorul să rămână în afară.

Date tehnice:



Cod: MS60

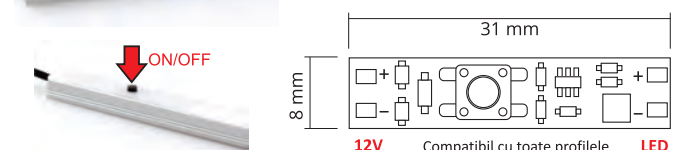

124. Z-CT

Set cu transformator și comutator capacitiv. Set cu transformator și comutator prin atingere cu o capacitate totală care nu depășește 36W.

Date tehnice:

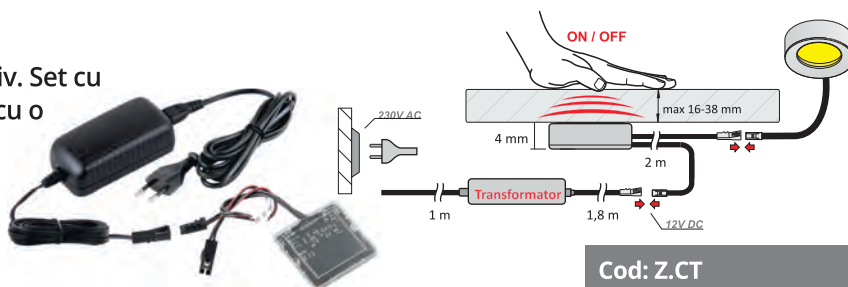

Cod: Z.CT

125. CONTROLER CU TELECOMANDĂ RF, DISTRIBUTOR CU 6 IEȘIRI

Dispozitiv modern cu funcție de dimmer și funcție de clipire. Este perfect pentru LED-urile mono-culore, inclusiv benzi LED, corpuri de iluminat cu LED sau miniprofile pentru polițe de sticlă.



Scanează codul QR și vezi cum funcționează.

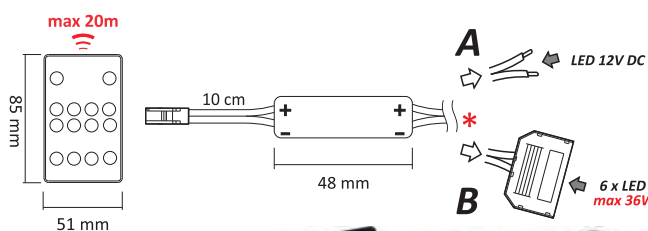

Date tehnice:



Cod: MONO.RF6

126. DIMMER RF LED CU TELECOMANDĂ

Dimmerul RF reglează intensitatea luminii printr-o telecomandă. Dimmer-ul poate fi acționat de mai multe telecomenzi.

Date tehnice:

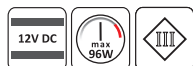

Cod: DIMMER

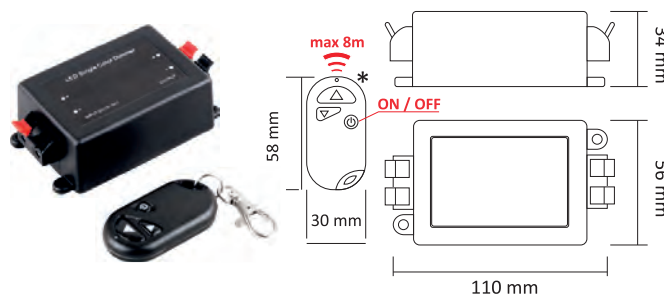

127. CABLU CU ȘTECHER EURO

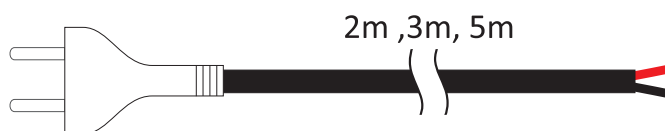

Cod	Finisaj
EURO.2M.A	Alb
EURO.2M.N	Negru
EURO.3M.A	Alb
EURO.3M.N	Negru
EURO.5M.A	Alb
EURO.5M.N	Negru

128. CABLU CU ȘTECHER EURO ȘI COMUTATOR PC1

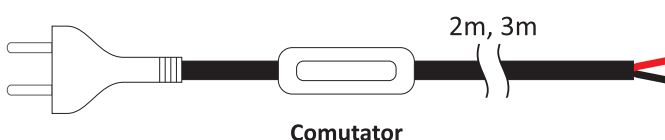

Cod	Finisaj
PC1.2M.A	Alb
PC1.2M.N	Negru
PC1.3M.A	Alb
PC1.3M.N	Negru

129. MULTI BOX

Priză retractabilă cu încărcare prin inducție și porturi USB și RJ45. Multi Box este priză ideală pentru săli de conferințe și birouri (de acasă sau din companii). Priză universală, oferă posibilitatea de a conecta dispozitive multiple și de a încărca telefonul mobil prin încărcătorul cu inducție. Se montează și se utilizează cu ușurință.

Cod	Descriere	Finisaj
MULTIBOX	Multi Box	Negru

Date tehnice:



130. SAMBO BOX

Priză retractabilă cu încărcător inductiv, port USB și module interschimbabile. Sambo Box este o priză practică, prin dimensiuni și dotări, utilă cu precădere pentru birouri și mobilierul de bucătărie și living. Ocupă un spațiu redus și este adaptabilă datorită modulelor interschimbabile HDMI și RJ45.

Cod	Descriere	Finisaj
SAMBOBOX	Sambo Box	Negru
SAMBOBOX-MOD-RJ45	Modul RJ45	Negru
SAMBOBOX-MOD-HDMI	Modul HDMI	Negru

Date tehnice:



Modul Interșanjabil HDMI



Listă preț
Prize Design Light



Modul Interșanjabil RJ 45



Port USB

131. INBOX

Priză încastrabilă cu porturi USB, RJ45, HDMI.
Inbox este o priză practică, cu porturi USB, RJ45 și HDMI. Contribuie la o organizare mai eficientă a spațiului de lucru și aduce un plus de funcționalitate prin posibilitatea închiderii capacului peste cablurile conectate.

Cod	Descriere	Finisaj
INBOX-AL	Inbox	Aluminiu
INBOX-N	Inbox	Negru

Date tehnice:

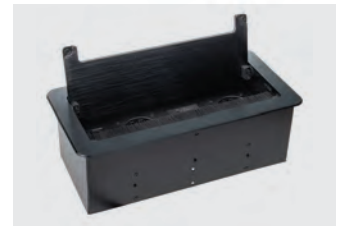
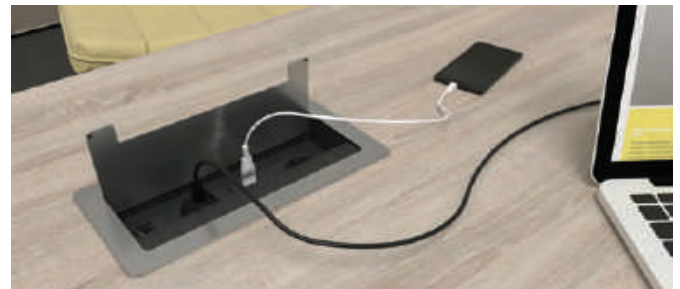

132. HOP BOX

Sistem de prize încastrabil, cu 3 prize schuko și 2 porturi USB. Prin design-ul ergonomic și funcția extractibilă, Hop Box este gândită pentru a ocupa cât mai puțin spațiu, cu maxim de funcționalitate.

Cod	Descriere	Finisaj
HOPBOX	Hop Box	Negru

Date tehnice:



133. DESK BOX

Sistem de prize echipat cu 3 prize schuko și port USB dublu. Sistem portabil foarte confortabil, poate fi prins pe diferite tipuri de blaturi și oferă acces facil la prize și la porturile USB. Cu o lățime de 7,5 cm, Desk Box se va încadra perfect pe marginea oricărui spațiu de lucru, fără a incomoda persoanele care lucrează la birou.

Cod	Descriere	Finisaj
DESKBOX	Desk Box	Aluminiu



134. SOFA BOX

Sistem cu 1 priză schuko, 2 x USB și cablu de 2,85 m. Sofa Box funcționează ca un prelungitor și încărcător USB. Fără să fie nevoie să vă ridicați de pe canapea, puteți conecta orice dispozitiv ce are nevoie de alimentare: laptop-ul, tableta sau telefonul. Dotat cu două tipuri de accesorii: unul pentru canapele și unul pentru suprafețe plane.

Cod	Descriere	Finisaj
SOFABOX.AL	Sofa Box	Aluminiu

Date tehnice

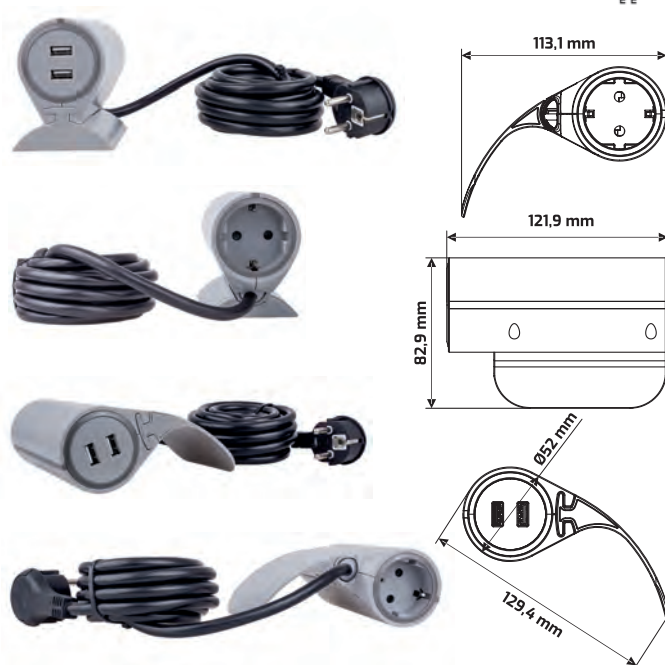

135. KOMBI BOX USB

Sistem de prize echipat cu 2 prize schuko și port USB dublu



- Încărcare rapidă**
Port USB dublu 5V/2,1A.
- Siguranță**
Prize 16A cu împământare și conductori cu secțiune de 1,5 mm².
- Design modern și ergonomic**
Marginile rotunjite aderă perfect la suprafața biroului.
- Ușor de folosit**
Se deschide la apăsarea butonului.
- Ușor de montat**
Cablul lung, de 3 metri. (3 x 1,5 mm²).
- Protecție**
Ștecher cu împământare.
- Calitate**
Carcasa rezistentă protejează cablurile contra deteriorării mecanice.

Disponibilă în trei finisaje, aluminiu, negru și alb.

Cod	Descriere	Finisaj
KOMBI.USB.AL	Kombi Box USB	Aluminiu
KOMBI.USB.N	Kombi Box USB	Negru
KOMBI.USB.A	Kombi Box USB	Alb

**Listă preț
Prize Design Light**

136. KOMBI BOX

Sistem de prize echipat cu 3 prize schuko, 3 m cablu cu ștecher



Dimensiuni Kombi Box USB și Kombi Box

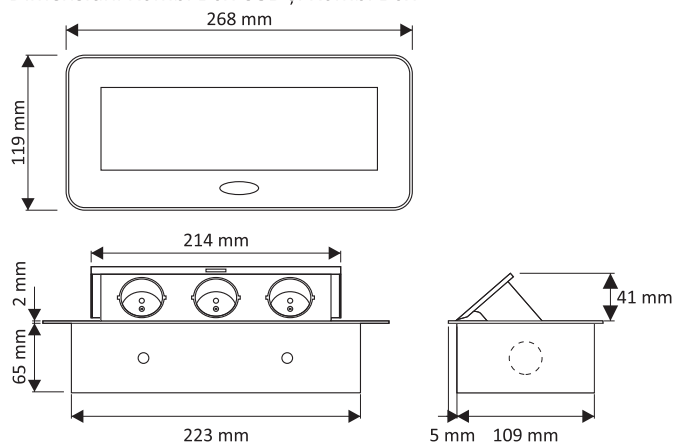

Date tehnice Kombi Box USB și Kombi Box



Finisaj ramă



Cod	Descriere	Finisaj
KOMBI.AL	Kombi Box	Aluminiu
KOMBI.N	Kombi Box	Negru
KOMBI.A	Kombi Box	Alb

137. CORNER BOX USB

Priză colț cu 2 prize schuko și cablu de 1,8 m, cu port USB

Cod	Descriere	Finisaj
CORNER.USB.AL	Corner Box USB	Aluminiu
CORNER.USB.A	Corner Box USB	Alb

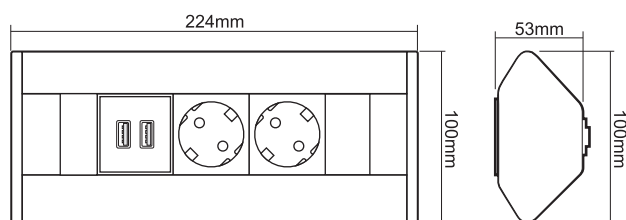

138. CORNER BOX

Priză colț cu 3 prize schuko și cablu de 1,8 m

Cod	Descriere	Finisaj
CORNER.AL	Corner Box	Aluminiu
CORNER.A	Corner Box	Alb

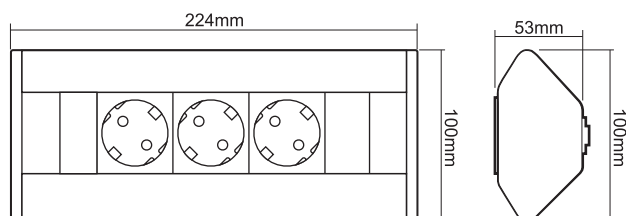

139. CORNER BOX 4

Priză colț cu 4 prize schuko și cablu de 1,8 m

Cod	Descriere	Finisaj
CORNER.4.AL	Corner Box 4	Aluminiu

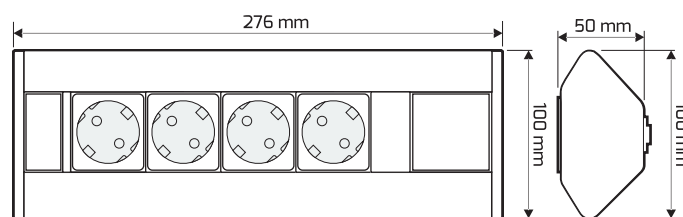

Date tehnice Corner Box USB, Corner Box și Corner Box 4



Finisaj ramă



140. LIFT BOX AUTOMATIC

Priză turn retractabilă automată, cu 3 prize schuko și cablu de 2 m, cu port USB.

Activarea dispozitivului - atingeți simbolul On/Off timp de aproximativ 2 secunde - butonul va emite o lumină verde. Atingeți încă o dată butonul, iar priză Lift Box se ridică. Pentru închiderea dispozitivului, atingeți scurt comutatorul dacă este iluminat (dispozitiv activ) sau atingeți 2 secunde comutatorul când dispozitivul este inactiv (simbolul nu este iluminat), apoi o atingere scurtă pentru retractarea dispozitivului. Dacă dispozitivul detectează un obstacol în timpul ridicării sau retractării, acesta se oprește automat.



Date tehnice

Finisaj ramă



Cod	Descriere	Finisaj
LIFT.AUTO.AL	Lift Box Automatic	Aluminiu
LIFT.AUTO.N	Lift Box Automatic	Negru

Scanează codul QR și vezi cum funcționează.

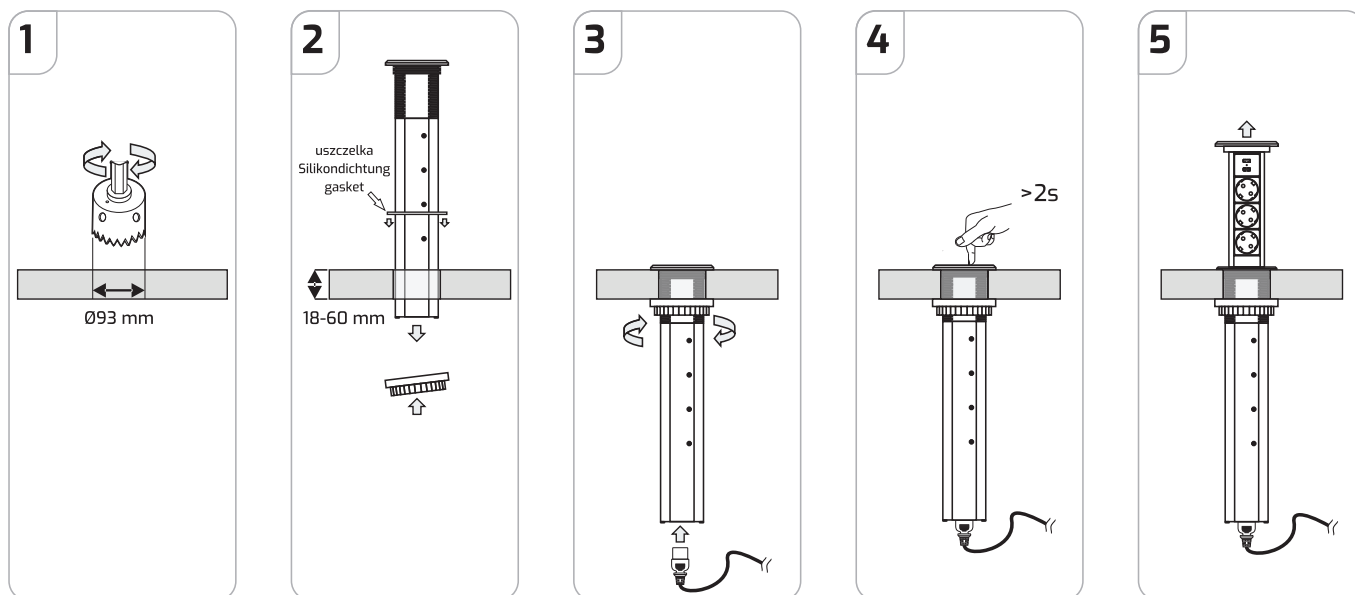
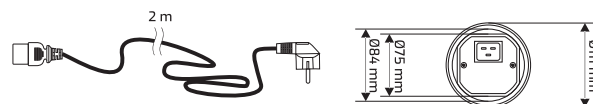
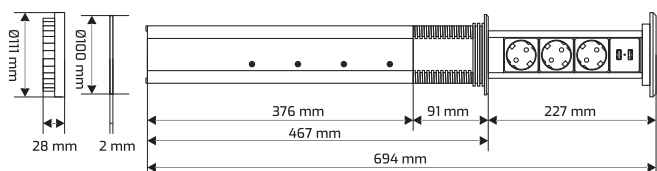

141. LIFT BOX USB

Priză turn retractabilă cu 3 prize schuko și cablu de 1,8 m, cu port USB

Cod	Descriere	Finisaj
LIFT.USB.AL	Lift Box USB	Aluminiu
LIFT.USB.N	Lift Box USB	Negru
LIFT.USB.IN	Lift Box USB	Inox



Aluminiu



Negru



Inox

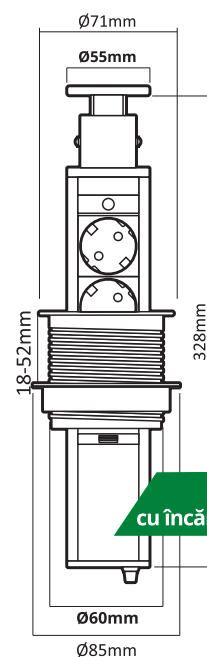

Port USB dublu
cu încărcător DC 5V / 2,1A

142. LIFT BOX

Priză turn retractabilă cu 3 prize schuko și cablu de 1,8 m

Cod	Descriere	Finisaj
LIFT.AL	Lift Box	Aluminiu
LIFT.N	Lift Box	Negru
LIFT.IN	Lift Box	Inox



2 x USB max. DC 5V/2,1A
3 x max. 16A



Funcționalitate și ergonomie



60 mm diametru



Aluminiu



Negru



Inox

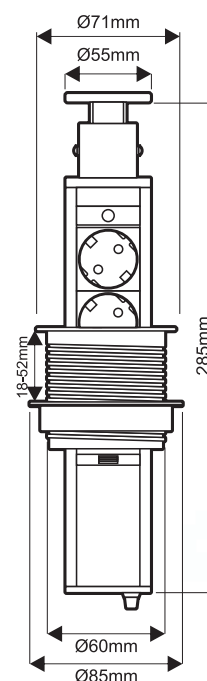

Scanează codul QR
și vezi cum funcționează.

Date tehnice Lift Box USB și Lift Box

Finisaj ramă



143. PRIZĂ PENTRU MOBILIER BAIE

Priză cu capac și comutator integrat, IP 44

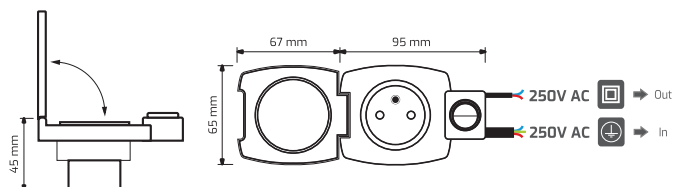

Cod	Descriere	Finisaj
GNI.A	Priză baie	Alb

Date tehnice



144. TETRA BOX USB

Sistem de prize retractabil echipat cu 3 prize schuko și port USB dublu

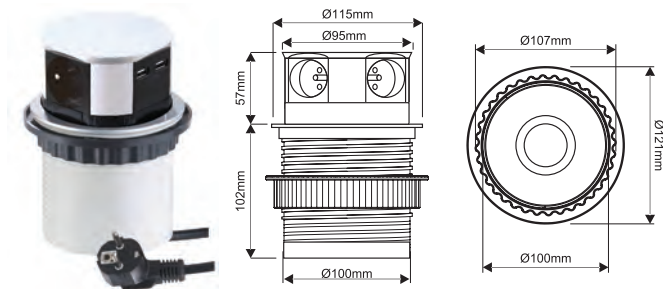

Date tehnice

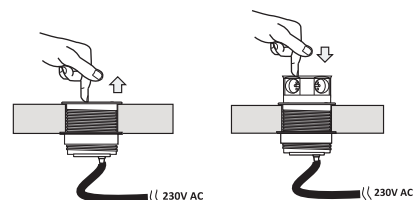
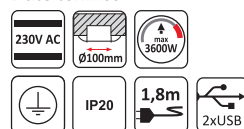

Cod	Descriere	Finisaj
TETRABOX.USB	Tetra Box USB	Aluminiu

145. SINGLEBOX

Sistem de prize echipat cu 1 priză schuko și port USB

Date tehnice



Cod	Descriere	Finisaj
SINGLEBOX	Singlebox	Aluminiu

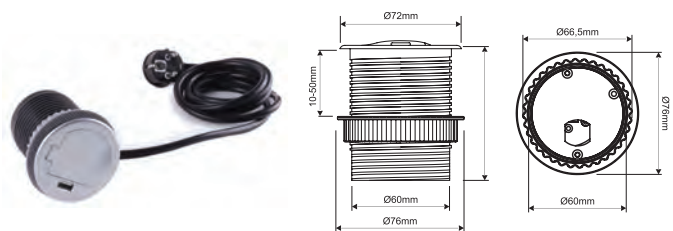

146. CONVERTOR 2 X USB, MONTAJ ÎNCASTRAT

Convertorul este dotat cu 2 porturi USB la care puteți conecta un smartphone, tabletă sau orice alt dispozitiv cu USB pentru încărcare. Pentru a obține cea mai bună performanță, se recomandă conectarea unei surse 12V DC cu o capacitate de min. 25-30W.

Cod	Descriere
USB.2	Convertor

Date tehnice

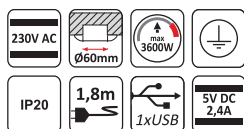

Scanează codul QR și vezi cum funcționează.

10 LEGENDĂ SIMBOLURI

	Dispozitiv alimentat cu voltaj V AC sau V DC		Clasa de protecție III. Asigurată de o sursă de energie cu voltaj scăzut SELV (≤ 50 V AC) sau PELV (≤ 120 V AC)
	Putere maximă		Lungimea cablului cu minimufă
	Gradul de protecție (IP)		Lungimea cablului cu ștecher
	Distanța minimă față de sursa de lumină		Lungimea cablului cu minimufă RGB
	Cote de montaj		În conformitate cu normele CE
	Comutator cu senzor PIR		Certificat TÜV care atestă siguranța și calitatea produsului
	Comutator cu senzor IR		Certificat care atestă siguranța produsului și a echipamentului
	Transformator rezistent la scurtcircuit		Dispozitiv a cărui instalare este permisă în contact direct cu materiale încadrate la combustibilitate normală
	Transformator parțial rezistent la scurtcircuit		Compatibilitate electromagnetică
	Factorul de putere (raportul dintre puterea activă și puterea aparentă)		Pentru uz exclusiv la interior
	Echipament potrivit pentru instalarea pe mobilier. (pentru montaj pe arii nespecificate)		Deșeu care se colectează selectiv
	Clasa de protecție I. Echipamente cu izolare ale pieselor, dar și cu o securizare suplimentară la conexiunea conductorilor cu acces la împământare.		Temperatura maximă care declanșează siguranța termică
	Clasa de protecție II. Asigurată de izolare dublă sau suplimentară.		

Culoare lumină

	Lumină rece		Portocalie
	Lumină caldă		Roșie
	Lumină neutră		RGB
	Albastră		
	Verde		

Finisaje

	Aluminiu		Inox
	Alb		Crom
	Negru		Maro
	Metal periat		Gri
	Antichizat		

Eficiență

	Clasa A++
	Clasa A+
	Clasa A

Informații generale pentru instalarea transformatoarelor

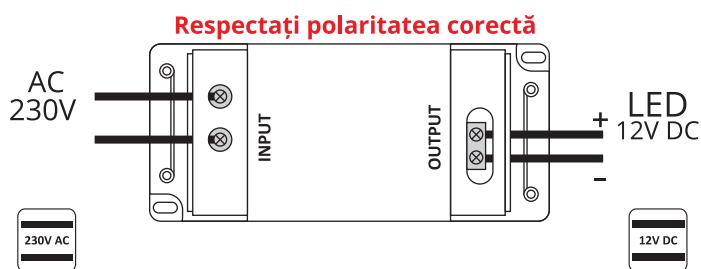

Se recomandă ca puterea consumată de sistem să fie maxim 80% din puterea transformatorului în cazul funcționării continue

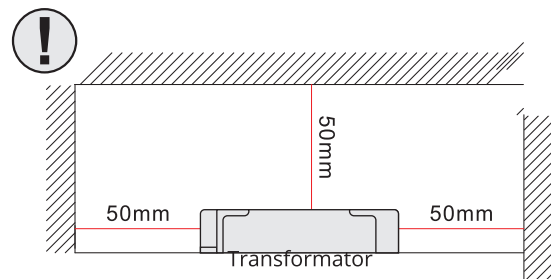

Transformatorul trebuie montat într-un loc bine ventilat. Distanța față de orice obstacol trebuie să fie min. 50 mm pentru a permite circulația aerului și dispersarea căldurii în mod corespunzător.

Toate produsele din acest catalog respectă normele:



ÎNTR-O LUMINĂ BUNĂ

3 sfaturi pentru iluminarea bucătăriei

1. Folosește iluminatul în straturi (sau "pe layer")

Cea mai eficientă modalitate de a ilumina o bucătărie este folosirea celor 3 layer: general, funcțional și de accent.

Rezultatul: o bucătărie în care fiecare element de design se îmbină armonios și creează un spațiu funcțional și plin de viață.



2. Începe cu iluminatul funcțional

Dacă singura sursă de lumină este cea clasică, provenită din tavan, vei avea cu siguranță umbre exact în zonele de lucru, care, de obicei, sunt orientate către perete.

Iluminatul funcțional permite îndeplinirea unor activități specifice în diferite zone ale bucătăriei: pe blatul de lucru, în sertare sau în dulapuri, în zona chiuvetei.

Folosește spoturi sau bandă LED pentru partea de jos a corpurilor superioare. Pentru sertare sau interiorul corpurilor de mobilier, montează profile cu bandă LED și senzor, care se activează la mișcare.

Asigură-te că folosești profile din aluminiu pentru integrarea benzii LED: acestea o protejează de praf și apă, iar difuzorul opac asigură o distribuție uniformă a luminii.

3. Nu uita de iluminatul de accent

Chiar dacă rolul principal al bucătăriei este unul funcțional, nu ai de ce să nu creezi aici o atmosferă plăcută. Pune în valoare obiectele pe care le iubești sau chiar piesele de mobilier, folosind corpuri de iluminat ce orientează lumina în diferite unghiuri sau care creează contraste prin strălucire și umbre.

